

**SANAKO Lab 100 v. 8.0**

# **USER GUIDE**

Copyright © 2002-2009 SANAKO Corporation. All rights reserved.  
Microsoft is a registered trademark. Microsoft Windows 2000 and Windows XP are trademarks of Microsoft Corporation. College Board, Advanced Placement Program, AP, and the acorn logo are registered trademarks of the College Entrance Examination Board.

MPEG Layer-3 audio coding technology licensed from Fraunhofer IIS and Thomson. Supply of this product does not convey a license nor imply any right to distribute MPEG Layer-3 compliant content created with this product in revenue-generating broadcast systems (terrestrial, satellite, cable and/or other distribution channels), streaming applications (via Internet, intranets and/or other networks), other content distribution systems (pay-audio or audio-on-demand applications and the like) or on physical media (compact discs, digital versatile discs, semiconductor chips, hard drives, memory cards and the like). An independent license for such use is required. For details, please visit <http://mp3licensing.com>.

This document covers SANAKO Lab 100 version 8.0.

Document date 18 September, 2009

Product Code: 1870123-9261



### SANAKO Corporation

P.O. Box 41, FI-20741 Turku, Finland  
Phone +358 2 2166 500 • Fax +358 2 2166 527  
[support@sanako.com](mailto:support@sanako.com), [info@sanako.com](mailto:info@sanako.com), <http://www.sanako.com>  
SANAKO User Club and Discussion Forum:  
<http://members.sanako.com>

# CONTENTS

|  |           |
|--|-----------|
| <b>About this Guide</b>                        | <b>1</b>  |
| To find the right information .....            | 1         |
| Typographic conventions .....                  | 1         |
| <b>Overview</b>                                | <b>2</b>  |
| What is SANAKO Lab 100? .....                  | 2         |
| The essentials of SANAKO Lab 100 .....         | 2         |
| Product components .....                       | 3         |
| Graphical User Interface .....                 | 3         |
| Program Source Interface .....                 | 4         |
| Media Storage Unit .....                       | 4         |
| System Connection Unit .....                   | 4         |
| User Audio Panel .....                         | 4         |
| SANAKO Lab 100 activities and sessions .....   | 4         |
| SANAKO Lab 100 activities .....                | 5         |
| SANAKO Lab 100 sessions .....                  | 5         |
| Self-access workstations .....                 | 6         |
| Teacher's Graphical User Interface (GUI) ..... | 7         |
| Components of the Lab 100 main window .....    | 7         |
| Toolbar .....                                  | 7         |
| Class view .....                               | 9         |
| Session Screen .....                           | 9         |
| Tooltips .....                                 | 10        |
| Session Status Bar .....                       | 11        |
| User Audio Panel .....                         | 12        |
| Keys on the User Audio Panel .....             | 13        |
| LCD display .....                              | 15        |
| Symbols on the Lab 100 LCD .....               | 15        |
| Clicking on a student icon .....               | 17        |
| Student icons .....                            | 17        |
| <b>Getting Started</b>                         | <b>21</b> |
| Starting Lab 100 .....                         | 21        |
| To start Lab 100 .....                         | 21        |
| Lab 100 main window .....                      | 21        |
| Lab 100 main menu .....                        | 22        |
| Copy files to/from MSU .....                   | 22        |
| Properties .....                               | 24        |
| Properties - Properties Tab .....              | 25        |
| Properties - Podcast options tab .....         | 26        |
| My Settings .....                              | 30        |
| My Settings - Properties tab .....             | 31        |
| My Settings - Activity options tab .....       | 35        |
| Self-access setup .....                        | 37        |
| Podcast Manager .....                          | 38        |
| Reset window positions .....                   | 41        |
| About .....                                    | 41        |
| Exit .....                                     | 41        |

|  |    |
|--|----|
| Seating Plan .....                       | 43 |
| Choosing a seating plan .....            | 43 |
| Setting a default Seating Plan .....     | 43 |
| Creating a seating plan folder .....     | 44 |
| Opening a seating plan folder .....      | 45 |
| Removing a seating plan folder.....      | 45 |
| About modifying the default folder.....  | 45 |
| Removing individual seating plans .....  | 46 |
| Seating Plan Report .....                | 46 |
| Attendance .....                         | 47 |
| Taking attendance .....                  | 47 |
| Attendance Report.....                   | 48 |
| Giving a new name.....                   | 50 |
| New Session.....                         | 51 |
| Selecting students for a session.....    | 51 |
| Removing a student from a session .....  | 51 |
| Activities in the Lab 100 sessions ..... | 52 |

## **Audio Connections 55**

|                                  |    |
|----------------------------------|----|
| Recordings .....                 | 55 |
| Activity Options.....            | 57 |
| Audio Source .....               | 58 |
| Media File .....                 | 59 |
| MSU File .....                   | 60 |
| PC Audio CD .....                | 62 |
| Student .....                    | 62 |
| Teacher .....                    | 63 |
| Teacher PC .....                 | 63 |
| Line In.....                     | 63 |
| Video audio.....                 | 63 |
| Monitor and intercom.....        | 64 |
| Monitor.....                     | 64 |
| Intercom.....                    | 65 |
| Intercom and Model Student ..... | 66 |
| Intercom and Free mode .....     | 66 |
| Recorder Controls .....          | 66 |
| Automonitor .....                | 66 |
| Bookmarks.....                   | 67 |
| Calls.....                       | 68 |
| All call .....                   | 68 |
| Session call .....               | 68 |
| Student call.....                | 69 |
| Outside call.....                | 69 |

## **Activity Procedures 70**

|  |    |
|--|----|
| General procedure.....                             | 70 |
| Saving, podcasting and collecting the tracks ..... | 74 |
| Using the Lab 100 Recovery Application .....       | 76 |
| Grading students .....                             | 78 |
| Grading report .....                               | 80 |
| Selecting a student to answer a question.....      | 81 |
| Free and Lock mode.....                            | 82 |
| Listening Comprehension.....                       | 84 |
| Proceeding with Listening comprehension.....       | 84 |
| Model Imitation .....                              | 87 |
| Proceeding with Model Imitation .....              | 87 |
| Reading Practice .....                             | 90 |
| Proceeding with Reading Practice .....             | 90 |
| Phone Conversation .....                           | 92 |

|   |     |
|---|-----|
| Proceeding with Phone Conversation.....         | 92  |
| Pair Discussion .....                           | 94  |
| Proceeding with Pair Discussion .....           | 94  |
| Group Discussion.....                           | 97  |
| Proceeding with Group Discussion .....          | 97  |
| Simultaneous Interpreting.....                  | 100 |
| Proceeding with Simultaneous Interpreting ..... | 100 |
| Consecutive Interpreting.....                   | 102 |
| Proceeding with Consecutive Interpreting .....  | 102 |
| Recorded Response .....                         | 104 |
| Proceeding with Recorded Response .....         | 104 |
| Quiz.....                                       | 106 |
| Proceeding with Quiz .....                      | 106 |
| AP® Exam.....                                   | 111 |
| Proceeding with the AP® Exam.....               | 111 |
| Library Mode .....                              | 117 |
| Proceeding with Library Mode .....              | 117 |
| GEPT .....                                      | 120 |
| Proceeding with the GEPT Exam .....             | 120 |
| TEM-4 .....                                     | 124 |
| Proceeding with the TEM-4 Exam .....            | 124 |
| Q&A.....  | 130 |
| Proceeding with Q&A.....                        | 130 |
| Audio-on-Demand.....                            | 131 |
| Proceeding with Audio-on-Demand .....           | 131 |

## **Lab 100 Setup 137**

|   |     |
|---|-----|
| Lab 100 installation .....                  | 137 |
| Hardware installation .....                 | 137 |
| Lab 100 components .....                    | 137 |
| Lab 100 connection overview .....           | 140 |
| Lab 100 SCU064 installation .....           | 141 |
| Dual Channel Program Source Interface.....  | 142 |
| Software installation.....                  | 143 |
| Minimum requirements .....                  | 143 |
| Installing the Lab 100 program .....        | 143 |
| Teacher PC configuration .....              | 143 |
| To set a workgroup .....                    | 144 |
| To complete the configuration.....          | 144 |
| Teacher PC sound card mixer setting .....   | 144 |
| Configuration of the Lab 100 software ..... | 146 |
| To configure the Lab 100 software .....     | 146 |
| Set default settings .....                  | 146 |
| Find workstations .....                     | 148 |
| Set video sources .....                     | 150 |
| Set audio sources .....                     | 151 |
| Set video connections.....                  | 155 |
| Setting up self-access workstations.....    | 156 |
| Troubleshooting .....                       | 158 |

## **Glossary of Terms 159**

## **Index 165**



# ABOUT THIS GUIDE

## TO FIND THE RIGHT INFORMATION

This is the user's guide of the SANAKO Lab 100 language learning system. This guide describes the functionality and use of the two main components of SANAKO Lab 100: the teacher and student user interfaces. For instructions on how to install and configure the system, see the Lab 100 Setup section in the end of this guide.

The first part of this guide gives you a general overview of the SANAKO Lab 100 language instruction center and its components.

The Getting Started section describes the basic functionality of the teacher's Graphical User Interface (GUI). You will learn how to create a class-specific layout and a SANAKO Lab 100 learning session.

In the latter part of this guide, you will learn how to facilitate your work and increase the possibilities to both teach and learn by using the different SANAKO Lab 100 features. The Activity Procedures section explains all the different SANAKO Lab 100 activities in detail.

Note that this User's Guide is also available as an online version.

## TYPOGRAPHIC CONVENTIONS

The following conventions are used in this guide:

|                |   |
|----------------|---|
| <b>Bold</b>    | Names of buttons, menu items, check boxes, fields, etc. |
| <i>Italics</i> | Signs and highlighted texts on the class view.          |
| →              | Cross-reference   |

# OVERVIEW

## WHAT IS SANAKO LAB 100?

The enhanced language instruction center SANAKO Lab 100 is a teacher-led language lab solution that operates logically and is therefore easy and fun to use.

The SANAKO Lab 100 center consists of the teacher and student interface. Both you and your students have a User Audio Panel. The User Audio Panel is the student's interface that includes recorder and volume controls and keys for setting, removing and searching for bookmarks, as well as for answering questions.

By using the audio panel, students can work individually with given or available audio material; set, remove and search for bookmarks, call the teacher, and answer questions. The difference between the teacher and student audio panel is that you, as teacher, can lock the recorder controls on the student panels and this way control the class. The teacher's user interface includes both the User Audio Panel and the SANAKO Lab 100 Graphical User Interface (GUI) on the teacher computer.

## THE ESSENTIALS OF SANAKO LAB 100

When your teaching tool is SANAKO Lab 100, you can divide your class into sessions for which you can then initiate different learning activities. A session can also cover the whole class.

### **SESSIONS**

The session-based thinking of the SANAKO Lab 100 program means that you can initiate different activities for the students to proceed with, and use different materials for each session. This way the students get a possibility to work with learning materials that correspond to their level and to get the maximum benefit of the teaching.



## ACTIVITIES

The variety of different types of SANAKO Lab 100 activities offers you all you need for efficient and versatile teaching and learning. Apart from the basic exercises, you can also make tests, and practice both consecutive and simultaneous interpreting.

## GUIDED PROCEEDING

Lab 100 is simple and fun to use because both its appearance and functionality are designed to meet the need for an undisturbed, fluently proceeding teaching situation. In SANAKO Lab 100, you don't have to worry about making a wrong move, since only those controls that are necessary for a particular phase of a program are available at that time.

## PRODUCT COMPONENTS

The SANAKO Lab 100 center is comprised of the following components: the Graphical User Interface (GUI) on the teacher PC, Program Source Interface (PSI), Media Storage Unit (MSU), System Connection Unit (SCU), and the User Audio Panels (UAP). The following diagram illustrates the different components and how they are connected with each other.

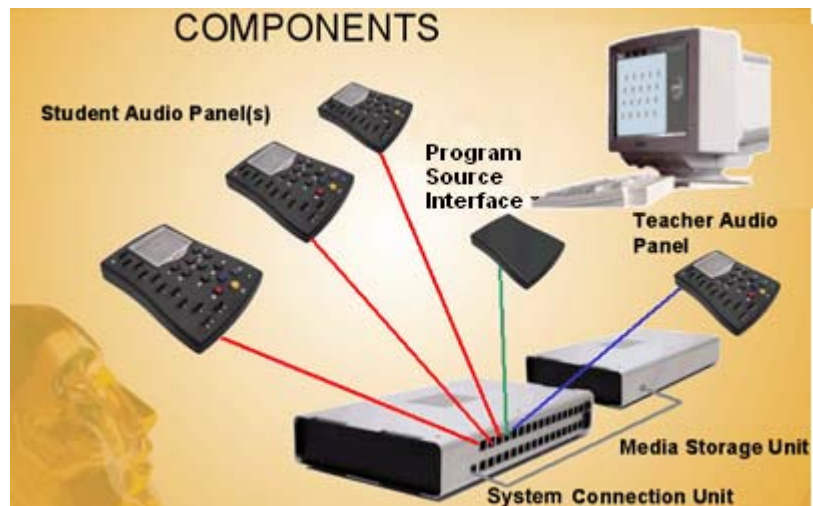

*The different components of the SANAKO Lab 100 learning center*

## GRAPHICAL USER INTERFACE

The SANAKO Lab 100 software provides the Graphical User Interface (GUI) at the teacher PC's monitor. The SANAKO Lab 100 GUI is the teacher workspace that displays the classroom layout. On the GUI, with a few mouse clicks you create sessions, where your students proceed with different activities.

## **PROGRAM SOURCE INTERFACE**

The Program Source Interface (PSI) allows the connection of any external audio source through its input jack. These sources can be connected to the students.

## **MEDIA STORAGE UNIT**

The Media Storage Unit (MSU) is the location where all the master and student recordings are saved. It is a separate digital unit that holds the audio files you want to access in the center. Media files can be copied to the Media Storage Unit from your computer. The recording capacity per student is up to 99 minutes and for the source files 120/240 hours.

## **SYSTEM CONNECTION UNIT**

The System Connection Unit (SCU) is the interface between the Media Storage Unit and students, as well as audio sources and your computer. It makes sure the audio connection between you and the students and/or audio source is successfully established.

## **USER AUDIO PANEL**

The User Audio Panel (UAP) is the student user interface, located on each student's desk. It is also part of your SANAKO Lab 100 user interface. On the Audio Panel are controls for working with the audio source, adjusting the volume, setting or removing bookmarks, and answering test questions.

# **SANAKO LAB 100 ACTIVITIES AND SESSIONS**

In SANAKO Lab 100, activities are what and how you are teaching and the students learning. SANAKO Lab 100 sessions are the settings within which you and your students proceed with the different exercises. For example, you can have one group of students practicing pronunciation and another group proceeding with listening comprehension. All you have to do is create two sessions, one for model imitation and one for listening comprehension. For each session you will select the participants, the desired activity, and an audio source (e.g. model imitation using an MP3 audio file), and then simply initiate the activity for the students to perform.

## SANAKO LAB 100 ACTIVITIES

The SANAKO Lab 100 language instruction center includes the following pre-programmed activities:

- Listening Comprehension
- Model Imitation
- Reading Practice
- Phone Conversation
- Pair Discussion
- Group Discussion
- Simultaneous Interpreting
- Consecutive Interpreting
- Recorded Response
- Quiz
- AP® Exam
- GEPT
- TEM-4
- Q&A
- Library Mode
- Audio-on-Demand

Pre-programmed activities are exercises that you assign to your students in SANAKO Lab 100 sessions. Based on the activity you select, the Session Screen guides you through the balance of the activity procedure.

For information on how to proceed with the different activities, see the descriptions in *Activity Procedures* later in this guide.

## SANAKO LAB 100 SESSIONS

A session is a group of students performing a learning activity. You can freely choose the number of participants; a session can consist of one single student, a number of students, or the whole class. Altogether you can have up to three sessions.

A session is the key concept of the SANAKO Lab 100 class and the session-based thinking shows in the design of the GUI. The Lab 100 sessions are color-coded, so on your screen you can easily view all relevant information and follow the right student icons.

## SELF-ACCESS WORKSTATIONS

In addition to the classroom student workstations that can be placed into sessions for instruction, Lab 100 also allows you to set up self-access workstations that can be located in a different room anywhere in the network and can be used by students at any time for listening to material and for independent study.

The self-access group operates outside the sessions in the teacher interface and outside teacher control. The teacher can define a list of MSU files to be available for the self-access group and students will then be able to study independently using the material. The teacher will also be able to call the self-access group when needed.

The self-access workstations can be defined in the Lab 100 Config application. For more information, see the chapter *Setting up self-access workstations* in the Lab 100 Setup section of this guide.

# TEACHER'S GRAPHICAL USER INTERFACE (GUI)

The following illustration shows the view that opens when you start the program.

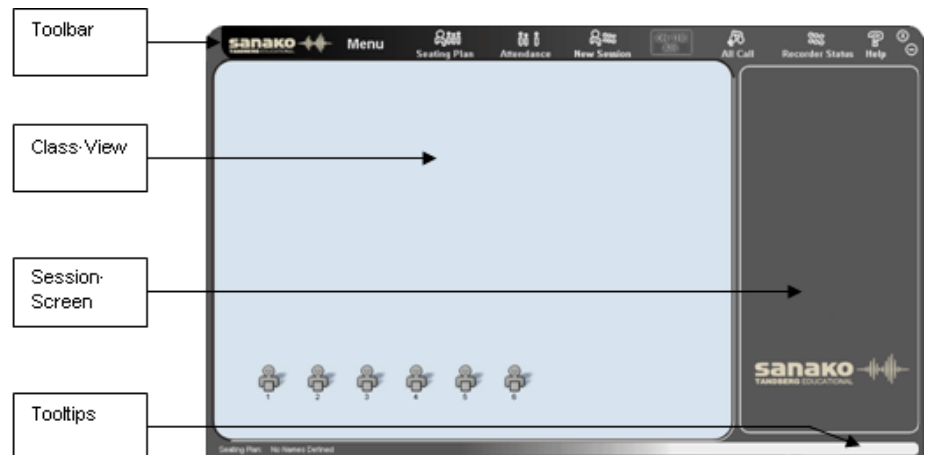

Lab 100 main window

## COMPONENTS OF THE LAB 100 MAIN WINDOW

The main components of the Lab 100 main window are the toolbar, class view, and Session Screen, as indicated in the illustration above.

## TOOLBAR



The Lab 100 toolbar is the horizontal bar on the upper part of the main window. On the toolbar, you find the basic functionality of the program: create or select a class set-up, take attendance, and create sessions. Additionally, you gain access to the Lab 100 main menu, and online help and comment via All Call with all the students in the class.

## LAB 100 MAIN MENU



Click the **Menu** button to open a drop-down menu, where you can copy files to/from MSU, edit properties and settings, view Lab 100 components' version numbers, and exit the program.

## SEATING PLAN



Click the **Seating Plan** button to select a class layout.

## **ATTENDANCE**



Click the **Attendance** button to assign each student to a position: to (re)name the students and to mark the absent students.

## **NEW SESSION**



Click the **New Session** button to create a session. Clicking this button opens the Session Screen, where you select and perform the activity.

## **ON THE AIR SIGN**



The *On the Air* sign is lit when your microphone is open and the student(s) can hear you.

## **HELP**



Click the **Help** button to access the Lab 100 online help.

## **ALL CALL**



Click the **All Call** button when you want to talk to the whole class.

→ For more details, see *Calls* later in this guide.

## **RECORDER STATUS**



Click the **Recorder Status** button to view the status of the student recorders in the student icons.



### ***Minimize the main window***

You may want to use other applications or the Internet while working with Lab 100. This is possible by minimizing the Lab 100 window to the taskbar. To minimize the window, click

this button. Clicking on the name of the program on the taskbar again restores the window.



### **Close the main window**

Click the button to close the window and exit Lab 100.

## **MOVING THE LAB 100 GRAPHICAL USER INTERFACE**

Note that the Lab 100 GUI is movable. When you point either side of the Lab 100 window or the Lab 100 logo in the upper left corner, the cursor turns into a four-headed arrow, and you can click and drag the user interface to a new position, or to a different monitor when you are working with two monitors.

## **POSITION OF THE LAB 100 APPLICATION WINDOW**

When you close the program, the current position of the Lab 100 main window is saved automatically. This means, that the next time you start the program, the application window opens in the same position on your screen as it was when you closed the program. The window's position is saved also when you are working with two monitors.

## **CLASS VIEW**

Class view is the layout of your class, in which your students are displayed as student icons.



Class view displays the seating plan of your class. By following this view, you keep track of the teaching situation.

The student icons change to reflect whether the student is in listen or speak mode.

→ The different student icons are described in chapter *Student icons*, later in this section.

## **SESSION SCREEN**

A session is a teaching situation for which you select participants and an activity they are to perform. The Lab 100 Session Screen is the part of the GUI where you proceed

with the session. In the Session Screen, you will select students, an activity, and an audio source for the session.



Session Screen before and after selecting an activity for the session

On the Session Screen appear the controls for the activity you select. For example, if you select the listening comprehension activity, only those controls, that are necessary to complete the listening comprehension activity, appear. Correspondingly, selecting a pair discussion opens controls that you need for the pairing students.

## SESSION TABS

The Lab 100 sessions are color-coded. Corresponding color highlighting on the panel views and on student icons helps you to keep track of the different sessions. Each Session Screen view has a color-highlighted session tab that indicates which session's controls are on the panel.

If you have created more than one session, the tabs of the 'hidden' panel views are dimmed on the Session Screen. You can easily switch between Session Screen views by just clicking on a session tab. You can also click on a Session Status Bar (see the following chapter *Session Status Bar*).

→ For a more detailed description on Lab 100 sessions, see chapter *New Session*, in the next section of this guide.

## TOOLTIPS

On the right-hand side of the bar you can view tips that guide you throughout the session.

For example, if you point a student icon while the students are performing a group discussion activity, the text on the status bar advises you on how to listen to the group's discussion.



On the left-hand side of the status bar is displayed the name of the current seating plan. To retrieve a seating plan, click the **Seating Plan** button on the toolbar.

## SESSION STATUS BAR

As you create sessions, color-coded status bars stack at the bottom of the Lab 100 window.





The Session Status Bar provides useful information about your sessions' status.

To gain access to other sessions' controls, click on the desired status bar.

### ACTIVITY



Displays the session's activity (e.g., listening comprehension) and status. The session status is either waiting, started, or paused.

-  Waiting: Session is not yet proceeding with an activity.
-  Started: An activity is initiated for the session.
-  Paused: Session's activity procedure is paused.

### SOURCE

Displays the audio source selected for the session, for example CD Audio.

### RECORDING TRACKS



*The Master Track is recorded*

- Displays which tracks are being recorded in the session. For example, in the simultaneous interpreting activity, both the student and master track are recorded, whereas in the reading practice, the program defaults for recording only the student track.

### **DURATION**

Displays the total time spent on activity (min: sec).

### **LOCK MODE**



Displays the student recorder status, *Locked* or *Free*.

In locked mode, the students are able to call the teacher, adjust the volume, and set bookmarks. However, they are not able to clear, search for or repeat bookmarks, or to use recorder functions.

In free mode, students are able to clear, search for or repeat bookmarks, and record to the student track.

## **USER AUDIO PANEL**

The User Audio Panel is the student's user interface, located on each student's desk.



## **KEYS ON THE USER AUDIO PANEL**

### ***CALL TEACHER / STUDEN LOGIN***

Students press to call teacher. A student symbol is shown on the display. Press again to cancel the call.

If the teacher has enabled the Student login function, students have to press the Call Teacher button at the beginning of the lesson to activate their student icon on the teacher interface.

### ***NUMBER KEYS: SET BOOKMARKS / QUIZ NUMERIC ANSWER / DIAL A PHONE NUMBER***

To set a bookmark, press the selected number key. The LED indicator of the key is lit.

To answer a Quiz question, press one of the blinking number keys. The LED indicator of the selected answer key is lit. The LED indicators of the other answer keys continue blinking until the teacher ends the answering mode. If the teacher indicates the correct answer, the student can see on the audio panel's display whether his/her answer was correct or incorrect.

In Phone Conversation, press these number keys to dial to another UAPs number.

### ***MODE***

A key for creating a loop of a selected segment of an audio.

→ See the description for *Repeat ON* and *Repeat OFF*.

### ***TRUE / FALSE***

Press to answer a true-false Quiz question. The LED indicator of the selected answer key is lit. The LED indicator of the other answer key continues blinking until teacher ends the answering mode.

### ***REPEAT ON***

The Repeat function creates a loop of a selected segment of an audio. The beginning and the end are marked with two bookmarks, and the segment can be played back over and over indefinitely. This is useful when you want to drill a phrase over and over again.

To mark the segment, in the audio panel, press and hold down the Mode key, and then press the bookmark keys you want to repeat. The LED indicators of the selected bookmark keys start to blink.

### **REPEAT OFF**

In the audio panel, press and hold down the Mode key, and press then the Clear key.

### **SEARCH FOR BOOKMARKS**

Press the key of the bookmark you want to find (the LED indicator of the set bookmarks is on).

The students can search for bookmarks only when their audio panels are in free mode.

### **REMOVE BOOKMARKS**

To remove a bookmark, press and hold down the Clear key, and then press the bookmark you want to remove. The LED indicator of the key switches off indicating that the bookmark is removed.

The students can remove bookmarks only when their audio panels are in free mode.

### **CLEAR**

In the AP® Exam and Phone Conversation, this key is used to clear the phone or exam ID number. Pressing the key once clears the last entered number.

### **VOLUME CONTROLS**

Press the volume control keys to set the volume for the audio source and the student. Pressing a volume control key once adds/removes one block on the volume bar. Pressing both of the volume controls (increase and decrease) simultaneously resets the default volume value.

### **RECORDER CONTROLS**

The recorder controls of the User Audio Panel are under teacher's control. The teacher disables the controls on the student panels by setting the Locked mode.

Press **Stop** to stop the playback and recordings.

Press **Speak** to play the master track and record to the student track.

Press **Recap** to return to the beginning of the previous sentence on the master track.

Press **Play** to play the master and student track.

Press **Rew** to rewind the master and student track. If you want to go directly to the beginning of the track, press the key twice. Pressing the key in play mode rewinds the tracks slowly.

Press **Ff** to fast-forward the master and student track. If you want to go directly to the end of the track, press the key twice. Pressing the key in play mode winds the tracks forward slowly.

## LCD DISPLAY

The liquid-crystal display (LCD) is the part on the User Audio Panel that shows the student and master track volume, the status of the student recorder, and the counter value (min:sec).

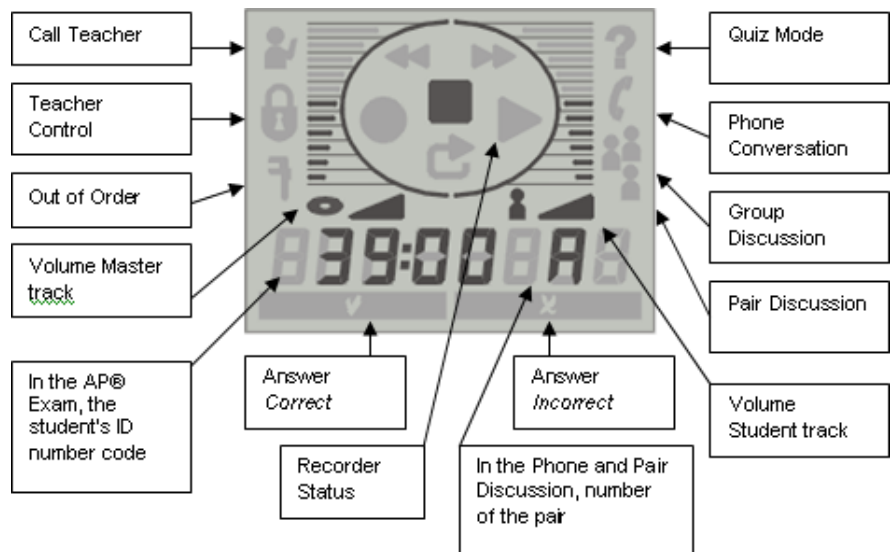

## SYMBOLS ON THE LAB 100 LCD

### VOLUME

The volume of the student and master track. The volume controls are always free for the student use, also when the panels are in the *Locked* mode.

### CALL TEACHER

When the student presses the Call Teacher key, a student symbol appears on the display.

### TEACHER CONTROL

When the lock symbol is shown on the display, it means that the students are able only to adjust the volume and set bookmarks. The recorder controls and all the other bookmark functions (search, remove and repeat) are disabled.

### OUT OF ORDER

The tool symbol is displayed when the student workstation is having problems communicating with the system and can't be used.

### **RECORDER STATUS**

The symbol of the student recorder status is shown on the display.

### **COUNTER VALUE**

Displays student recorder's counter value (min: sec).

### **CORRECT AND INCORRECT ANSWER**

In the Quiz, you can indicate to your students whether the answer to the question was *Correct* or *Incorrect*.

### **QUIZ MODE**

A question mark is shown when the audio panel is in the Quiz mode. This means that the number keys function now as numeric answer keys instead of bookmark keys.

### **PHONE CONVERSATION**

The phone symbol appears when the audio panel is in the Phone Conversation mode. This means that the students can now dial the number of a fellow student (for example 09) by pressing the number keys. The number appears on the display. If the connection is successfully established between the students, the pair discussion symbol is shown on the display. If the line is busy, the symbol of incorrect answer is lit.

### **GROUP DISCUSSION (3 STUDENT SYMBOLS)**

In the Group Discussion mode, three student symbols are shown on the display.

### **PAIR DISCUSSION (2 STUDENT SYMBOLS)**

In the Pair Discussion, two student symbols and the number of the pair student (for example 09) are shown on the display.

### **ID NUMBER CODE**

In the AP® Exam, the students are given an 8-numbered ID code. In the beginning of the exam, the students give their number codes, which then appear on the display.

### **PAIR NUMBER**

In Pair and Phone Conversation, the number of the pair is shown on the display.

## CLICKING ON A STUDENT ICON

Clicking on a student icon means pointing a student icon and pressing the left or right mouse button. Both the left and right mouse button has its function; you can call or monitor the student, or give the student an answering turn.

### **PRESSING DOWN THE LEFT MOUSE BUTTON**

- Except for the Session Call mode, left-clicking on a student icon always means monitoring the student. Clicking on a student icon with the left mouse button opens a monitoring panel, where you can see the student's recorder status, open an intercom connection and access the student's recorder control buttons. You can also see the grade that the student has been given, or type in a grade. To quit the monitoring panel, click anywhere on the class view.
  - For more information about monitoring a student, see chapter *Monitor and intercom*, later in this guide.
  - For more information about grading a student, see chapter *Grading students*, later in this guide.
- In the Session Call mode, left-clicking on the student means giving the student an answering turn. In a session, first pause or stop the activity. Then call the session by clicking the Session Call button and click on the selected student's icon. A speech bubble appears onto the icon to indicate that the students in the session can hear the answering student.
  - For more information about Session Call, see *Calls* later in this guide.

### **PRESSING DOWN THE RIGHT MOUSE BUTTON**

- Clicking on the student icon with the right mouse button means calling the student. This is useful when you need to say something shortly to one specific student without disturbing the others. The student hears you as long as you hold the right mouse button pressed down.

## STUDENT ICONS

The Lab 100 class view is a graphical layout of your class, where your students are displayed as student icons. Each student state has its icon. This way it is easy to see at a glance who is attending the class and who is absent, which session the students belong to, and which student workstations are not in use during the class. Additionally, the

student icons change to reflect whether the students are in a listen or speak mode.

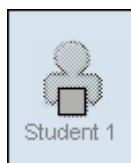

### **Absent student**

Student workstation is not used in this class or the student is not attending the class.

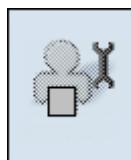

### **Student workstation out of order**

The student workstation cannot be used in this class.

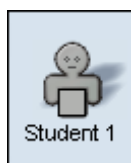

### **Student (basic)**

The student is not yet selected into a session.

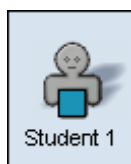

### **Session student**

The student is a member of a session. The Session student is color coded according to the session he or she belongs to.



### **Student in monitor**

The student is being monitored. Clicking on classroom breaks the connection to the active student(s).



### **Self-access workstation**

A self-access workstation that students can use for independent study outside the Lab 100 sessions and teacher control.

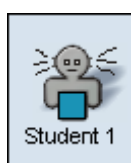

### **Student in listening mode**



Student hears you and the answering student.

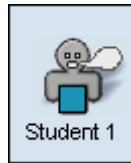

### Student in speak mode

All students in the session hear the answering student. Click on a student icon to give him or her the answering turn. In the student icon appears a speech bubble.

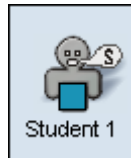

### Student as source

Student is the audio source for the session. A Source Student can be a member of any session or a student who doesn't belong to any session.

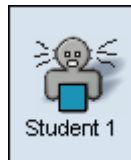

### Student in intercom

Student is in an intercom connection with you.

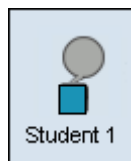

### Student recorder status

Clicking the **Recorder Status** button on the Lab 100 toolbar changes the student icons into symbols that display the student recorders' status.

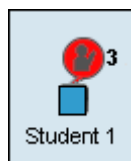

### Student calling

When students press the **Call Teacher** key on their audio panels, a call symbol appears above their student icon to indicate that they are calling you. In case several students call the teacher at the same time, a number next to the call symbol displays the order of the calls. After the teacher uses **Intercom** to talk to the students, the numbers are updated accordingly.



# GETTING STARTED

## STARTING LAB 100

### TO START LAB 100

1. On the Windows taskbar, click the **Start** button. The Windows main menu opens.
2. In the menu, point to **Programs**.
3. Point to SANAKO Lab
4. Click **Lab 100**.

## LAB 100 MAIN WINDOW

This is the main window of the Lab 100 Graphical User Interface. The main functionality of the Lab 100 program resides on the toolbar (1.) and Session Screen (2.).



The arrows indicate how you will proceed with a Lab 100 class. On the toolbar, you create the class layout and initiate a session. On the Session Screen, you will then select the activity for the session, and proceed with it.

# LAB 100 MAIN MENU

In the Lab 100 main menu you can copy files to/from MSU, set and change properties, set your personal default settings for activities and other features, set files for the self-access workstations, manage podcasts, set default positions for windows, view Lab 100 version information, and exit the program.

Clicking the **Menu** button opens the following drop-down menu. The different options are explained below.

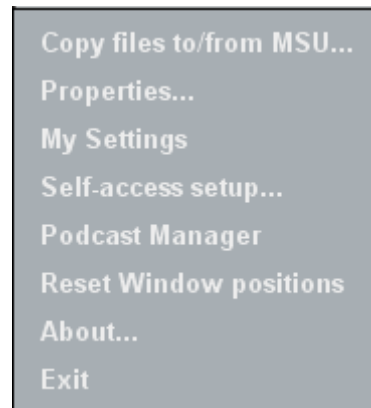

Lab 100 main menu

## COPY FILES TO/FROM MSU

Click to copy a media file or an entire folder from your computer to the Media Storage Unit, or vice versa. If you copy an entire folder to the MSU, only the audio files in the folder will be copied. Selecting this menu option opens the following dialog window.

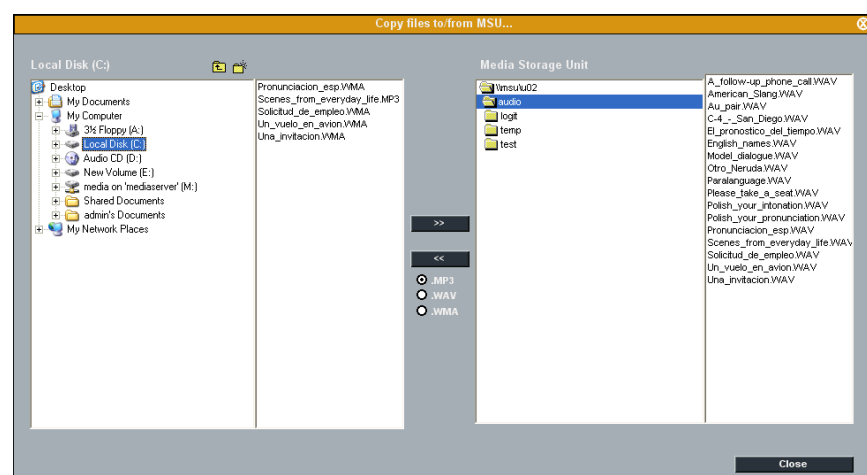

Dialog window for copying files and folders to and from the MSU

1. In the dialog window, select the file or folder that you want to copy on one side and the directory where you want to

copy it to on the other side, and then click the arrow button accordingly.



Arrow buttons for copying to or from the Media Storage Unit

- To copy files or folders to the Media Storage Unit, click the arrow button pointing to the right.
- To copy files or folders to your computer, click the arrow button pointing to the left.

Note that all the material is stored on the MSU in .WAV format. When you copy files from the MSU, you can select the file to be in .MP3, .WAV, or .WMA format.

Clicking the arrow button starts the copying. The following dialog window opens.

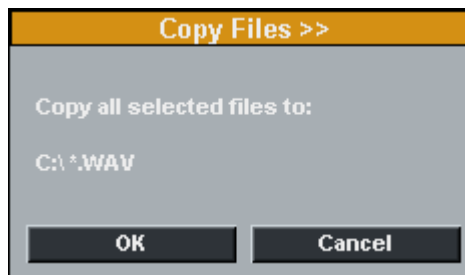

Dialog window for confirming the copy

2. To confirm the copying of files to the selected directory, click **OK**.

A window appears indicating the status of the file copying.

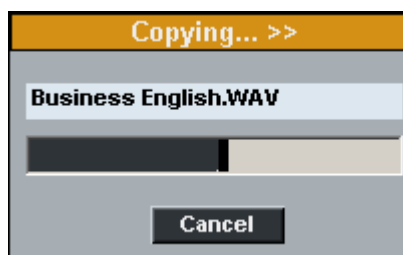

Dialog window shown during the file copy

When the file copy is completed, the dialog window disappears and the name of the copied file or folder appears on the selected location, i.e. in the **My Computer** or **Media Storage Unit** window.

## PROPERTIES...

Selecting **Properties** opens the Lab 100 Properties window. The Properties window has two tabs at the top for different settings.

- **Properties** – Set general Lab 100 settings
- **Podcast options** – Define settings related to podcasting audio material

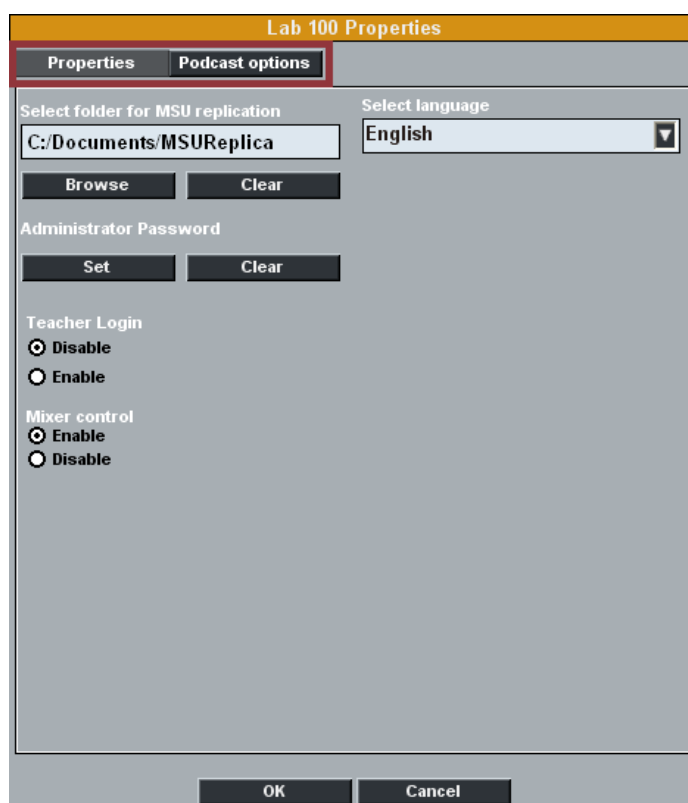

*Lab 100 properties window*

Note that if **Teacher Login** has been enabled, **Properties** are only available in the Lab 100 **Menu** if you have logged in as **Administrator**.

### **EXITING THE PROPERTIES WINDOW**

To save your choices and exit the Lab 100 Properties window, click **OK**. To exit the window without saving your changes, click **Cancel**.

## PROPERTIES - PROPERTIES TAB

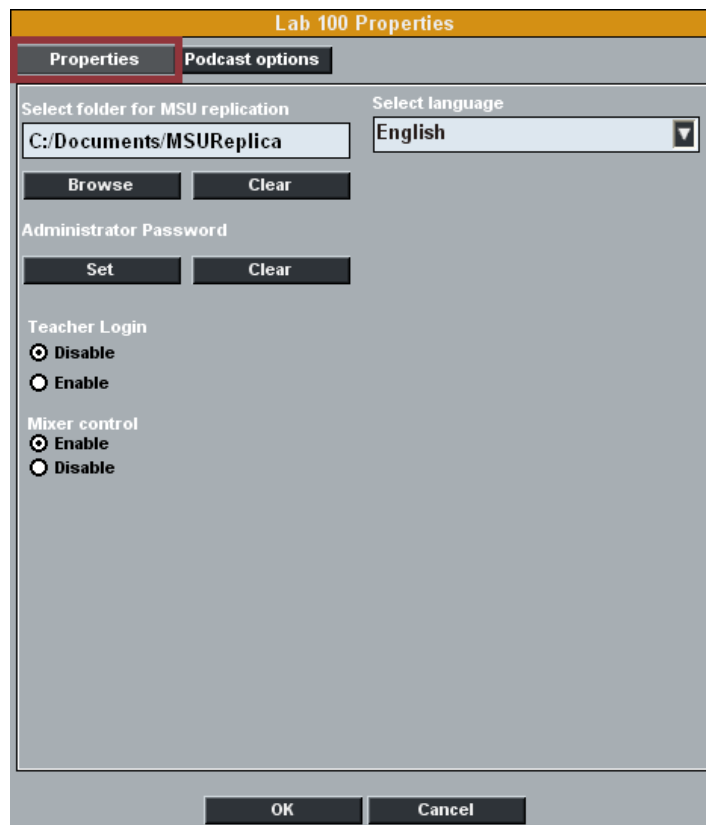

### ***TO SET A FOLDER FOR MSU REPLICATION***

All MSU content can be replicated to a shared area when Lab 100 is shut down. This makes it possible to use the MSU materials with other systems.

To select the default saving area for MSU replication, click **Browse** and browse for a suitable folder

### ***ADMINISTRATOR PASSWORD***

Lab 100 asks for the Administrator password when you try to login with the Administrator account in the Teacher Login window. By default no administrator password has been set.

For more information on teacher accounts, see *Teacher Login* below.

### ***TEACHER LOGIN***

When Teacher Login is enabled, Lab 100 will ask you to select your teacher account from a list when the Lab 100 teacher application is started.

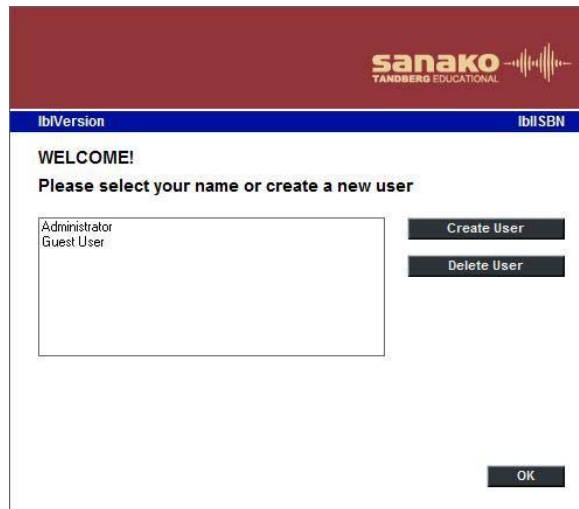

Select your account on the list, or **Guest User** if you have not been added to the system as a teacher. Lab 100 will then start with your personal settings, which have been defined in **My Settings** in the **Lab 100 Menu**.

To create a new user account, click on **Create User** and enter a name for the new teacher. The administrator account settings are used as the default for each new teacher. This helps you minimize the customization required for new teachers.

The **Administrator** and **Guest User** accounts cannot be removed. When **Teacher Login** has been enabled, only the Administrator account has access to the **Properties** option in the **Lab 100 Menu**. If an administrator password has been set, you will be asked to enter it when logging in as Administrator.

Note: All user data files are stored to C:\documents and settings\all users\shared documents\sanako\lab100\ (in XP) and to C:\users\public\public documents\sanako\lab100 (in Vista). Make sure you backup this folder regularly to maintain teachers' personal data.

### **TO SELECT A LANGUAGE**

1. Click on the field to open a list of available languages.
2. Select the desired language, and click **OK**.

### **PROPERTIES - PODCAST OPTIONS TAB**

Podcast options allow you to enable or disable the podcasting feature and to set up a Web server and remote directories for podcasts.





Please note that before you can podcast audio material in Lab 100, you need to:

1. Configure a Web server to host the podcasts. See *Properties - Podcast options tab* under *Lab 100 main menu*.
2. Create remote directories for the podcasts. See *Properties - Podcast options tab* under *Lab 100 main menu*.
3. Create RSS feeds for the remote directories. See *Podcast Manager* under *Lab 100 main menu*.

### **ENABLING AND DISABLING PODCASTING**

You can **enable** or **disable** the podcasting feature in Lab 100 under **Podcast feature**. When podcasting is enabled, you can create a podcast out of the audio material that is transferred to students during Lab 100 activities in which the Master track is recorded. When you end a Lab 100 activity in which the Master track is recorded, a dialog appears where

you can save the audio material as a podcast.



## CONFIGURING WEB SERVER

This part of the **Podcast options** tab allows you to configure the server that will be used to distribute the podcasts over the Internet.

To configure the podcasting server:

- Select an **FTP protocol** that corresponds with your Web server.  
The FTP protocol options use different ports to access the Web server and change the port number selection automatically.
- Under **Server address**, enter the address of the FTP server that hosts the podcast Web pages. The **port** number changes automatically according to your **FTP** selection.
- Enter a **Login name** and **Login password** that will be used to access the server
- Under **RSS File name** enter the Web page file that will be used to host the podcasts (e.g. index.xml).

## REMOTE DIRECTORIES

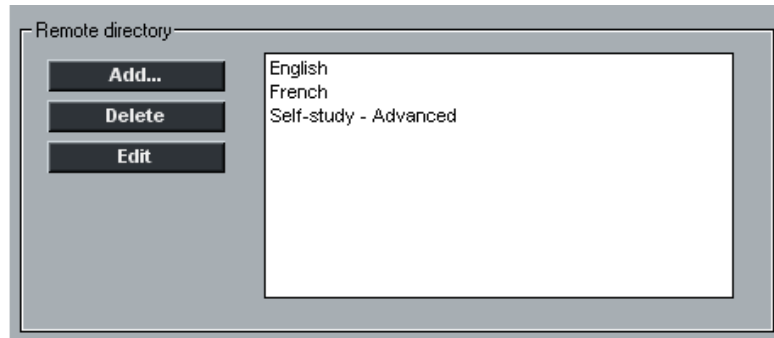

The lower part of the Podcast options tab allows you to set up and manage **remote directories** on the Web server for the podcasts. **Remote directories** allow you to set up a folder structure for podcast files on the Web server, as well as on the podcast Web page.

**To add a remote directory**, click **Add**. In the dialog that opens you need to define the following:

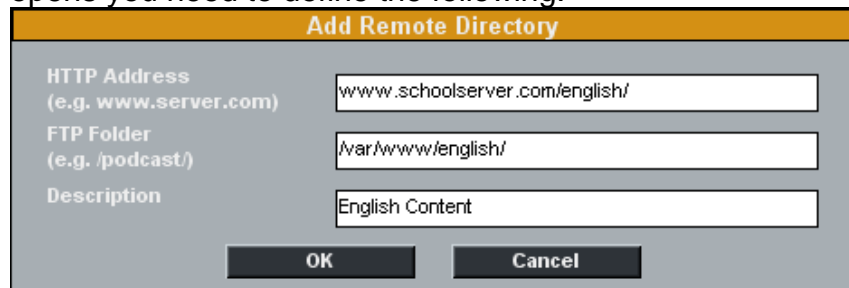

- **HTTP Address** – This is the internet address of the location where the content is published.
- **FTP Folder** – This is the name of the FTP folder that will correspond with the Web server path for this location.  
(e.g. In our example configuration, if the Web server path is “http://www.schoolserver.com/english/”, the remote FTP directory is “/var/www/english”)
- **Description** – Enter a descriptive name for this location. This name will be displayed in the remote directory list in the Podcast Options, as well as on the list of possible locations when you upload podcasts either with the Podcast Manager or after a Lab 100 activity

When you have filled in the information, click **OK** and the new location will be added to the remote directory list.

**To remove a remote directory**, select the directory on the list and click **Delete**.

**To edit a remote directory**, select a directory on the list and click **Edit**. This opens a dialog where you can edit the same

information as when creating a new directory.



**Modify Remote Directory**

Internet Subfolder: /english

Remote directory: /var/www/html/english

Description: english

OK Cancel

## MY SETTINGS

My Settings window allows you to define personal settings that will be saved into your own teacher profile. If Teacher Login has been enabled in Lab 100 Properties, your own settings will be loaded when you log into the system. My Settings has two tabs at the top for different settings.

- **Properties** – Set default folders, collection options and other teaching related settings
- **Activity options** – Edit your list of teaching activities and define activity related options.

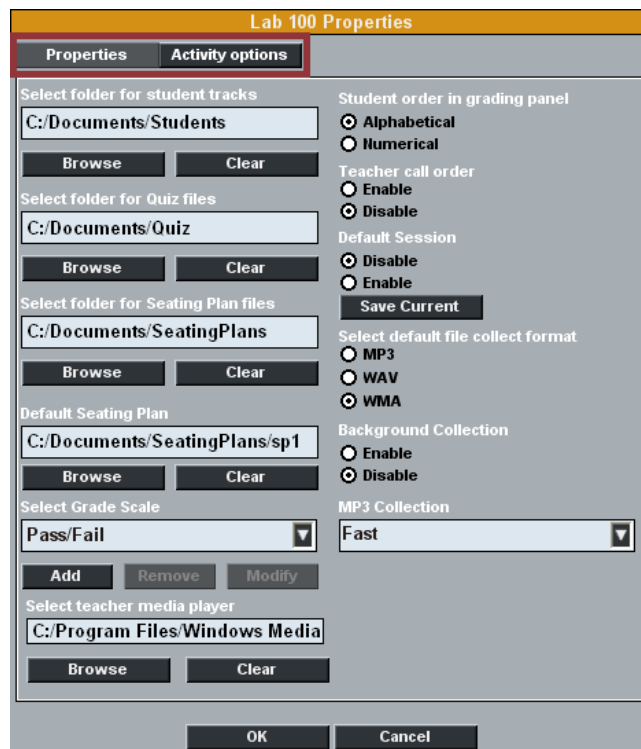

**Lab 100 Properties**

Properties Activity options

Select folder for student tracks: C:/Documents/Students

Select folder for Quiz files: C:/Documents/Quiz

Select folder for Seating Plan files: C:/Documents/SeatingPlans

Default Seating Plan: C:/Documents/SeatingPlans/sp1

Select Grade Scale: Pass/Fail

Select teacher media player: C:/Program Files/Windows Media

Student order in grading panel:  Alphabetical,  Numerical

Teacher call order:  Enable,  Disable

Default Session:  Disable,  Enable, Save Current

Select default file collect format:  MP3,  WAV,  WMA

Background Collection:  Enable,  Disable

MP3 Collection: Fast

Add Remove Modify

OK Cancel

## MY SETTINGS - PROPERTIES TAB

Lab 100 Properties

Properties Activity options

Select folder for student tracks  
C:/Documents/Students  
Browse Clear

Select folder for Quiz files  
C:/Documents/Quiz  
Browse Clear

Select folder for Seating Plan files  
C:/Documents/SeatingPlans  
Browse Clear

Default Seating Plan  
C:/Documents/SeatingPlans/sp1  
Browse Clear

Select Grade Scale  
Pass/Fail  
Add Remove Modify

Select teacher media player  
C:/Program Files/Windows Media  
Browse Clear

Student order in grading panel  
 Alphabetical  
 Numerical

Teacher call order  
 Enable  
 Disable

Default Session  
 Disable  
 Enable  
Save Current

Select default file collect format  
 MP3  
 WAV  
 WMA

Background Collection  
 Enable  
 Disable

MP3 Collection  
Fast

OK Cancel

### TO SET A COLLECTION FOLDER FOR STUDENT TRACKS

1. Click the **Browse** button. A dialog for browsing for a collection folder opens.
2. In the dialog, select a folder and click **OK**. The path of the selected folder appears in the Lab 100 Properties dialog.

If you don't select a folder in this dialog, the program prompts you to select a folder when collecting the student tracks. To clear the folder selection in the dialog, click **Clear**.

When a collection folder for student tracks has been defined, Lab 100 will create a subfolder under the default folder each time that student recordings are collected. Lab 100 will also prompt you to name the new subfolder before each collection.

However, if a collection folder for student tracks has been defined and the **Long filenames** option is enabled in My Settings, Lab 100 will not prompt you for a subfolder name, but instead will automatically create a new subfolder, which is named in the following manner: 'yyyy\_mm\_dd\_hhmm' (year\_month\_date\_hour and minute).

### **TO SET A FOLDER FOR QUIZ FILES**

You can save the settings used in the Quiz activity for later use. This allows you to simply load a ready Quiz file, instead of defining all the settings every time you run a Quiz.

To select the default folder for Quiz files, click **Browse** and browse for a suitable folder.

### **TO SET A FOLDER FOR SEATING PLAN FILES**

You can select the folder where your own seating plan files will be saved.

To select the folder for seating plan files, click **Browse** and browse for a suitable folder.

### **DEFAULT SEATING PLAN**

Select the seating plan file that will be used as the default seating plan when Lab 100 is started.

For information on creating seating plans, see the *Seating Plan* chapter later in this guide.

### **TO SELECT A GRADE SCALE**

1. Click on the Select Grade Scale field to open a list of the possible grade scales.
2. Select the appropriate grade scale. The default choice is Pass/Fail.

You can also create custom grade scales by clicking on the **Add** button. The Add new grade scale window opens.

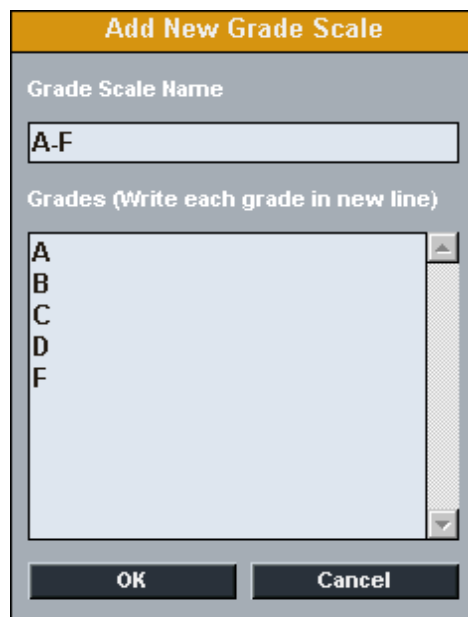

The screenshot shows a dialog box titled "Add New Grade Scale". It has a light gray background and a yellow title bar. The "Grade Scale Name" field contains the text "A-F". The "Grades (Write each grade in new line)" field contains a list of grades: "A", "B", "C", "D", and "F". At the bottom of the dialog are two buttons: "OK" and "Cancel".

Give a name for your grade scale in the Grade Scale Name field and type in all the possible grades in the Grades field.

Remember to type each new grade on a new line. Click **OK** to save the new grade scale or **Cancel** to exit without saving.

All custom grade scales can be removed and edited by clicking on the **Remove** and **Edit** buttons in the Properties window.

### ***SELECT TEACHER MEDIA PLAYER***

Select the media player application that will be used to play back the Media File and Audio CD audio sources during Lab 100 activities.

The default selection for teacher media player is Windows Media Player. If the field is left empty, then Lab 100 will use the media player that is associated with the current media file format when media files are used as the audio source.

### ***STUDENT ORDER IN GRADING PANEL***

You can select whether you want students to be listed in the Grading panel alphabetically, or according to their workstation numbers.

### ***TEACHER CALL ORDER***

Select whether the student icons will display the order in which the students have called the teacher, if several students call the teacher at the same time.

### ***TO SET THE DEFAULT SESSION SETTINGS***

To set the current session settings as the default option, select **Enable** under Default Session and click **Save Current**. The current settings are then used automatically when you start Lab 100. The saved settings include created sessions and their activities.

### ***SELECT DEFAULT FILE COLLECT FORMAT***

Select the file format in which student recordings will be saved when they are collected. The available options are mp3, wav and wma.

### ***BACKGROUND COLLECTION OF STUDENT RECORDINGS***

In Background Collection, student recordings are automatically saved as audio files to the default folder for student track collection, while an activity is running.

How to use Background Collection:

1. Go to **Menu – Properties**, and enable Background Collection.

2. Create a session and start an activity as usual. The audio source can be heard in student positions.
3. Starting the activity also starts Background Collection and opens a dialog prompting you to name the folder where the student recordings will be saved.

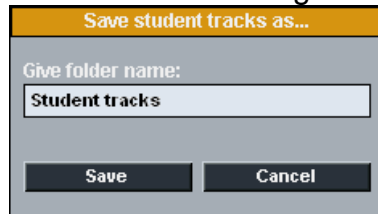

Enter a name and click **Save**. This creates a subfolder under the default path for student track collection.

4. The percentage number on the taskbar displays the status of background collection in relation to the amount of transferred material.



Double-click it to view this same information in the form of a bar.



5. When you end the activity, a saving window opens that displays the path where student recordings are collected and a bar indicating the status of the background collection.

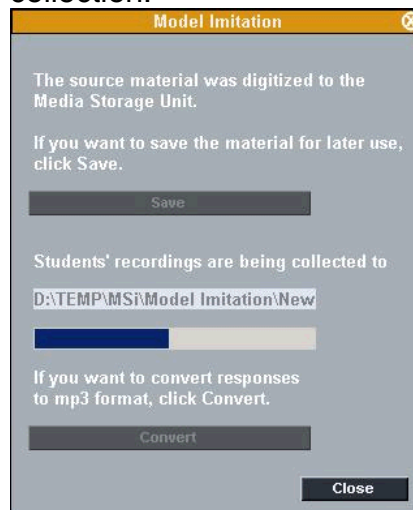

6. The **Save** and **Convert** buttons are grayed out until background collection has been completed. If you want to save the master track, click Save. If you want to convert student recordings to .mp3 format, click **Convert**.



## MP3 COLLECTION

Select the speed at which student recordings are collected as mp3 files.

**Fast** – Fastest collection rate, but quality of the recordings may be slightly affected.

**Standard** – Default collection rate

**Quality** – Slower collection, but recordings are saved with optimum audio quality.

## MY SETTINGS - ACTIVITY OPTIONS TAB

The **Activity options** tab in the Lab 100 Properties window allows you to select and name the activities to be displayed in the **Activity selection** list.

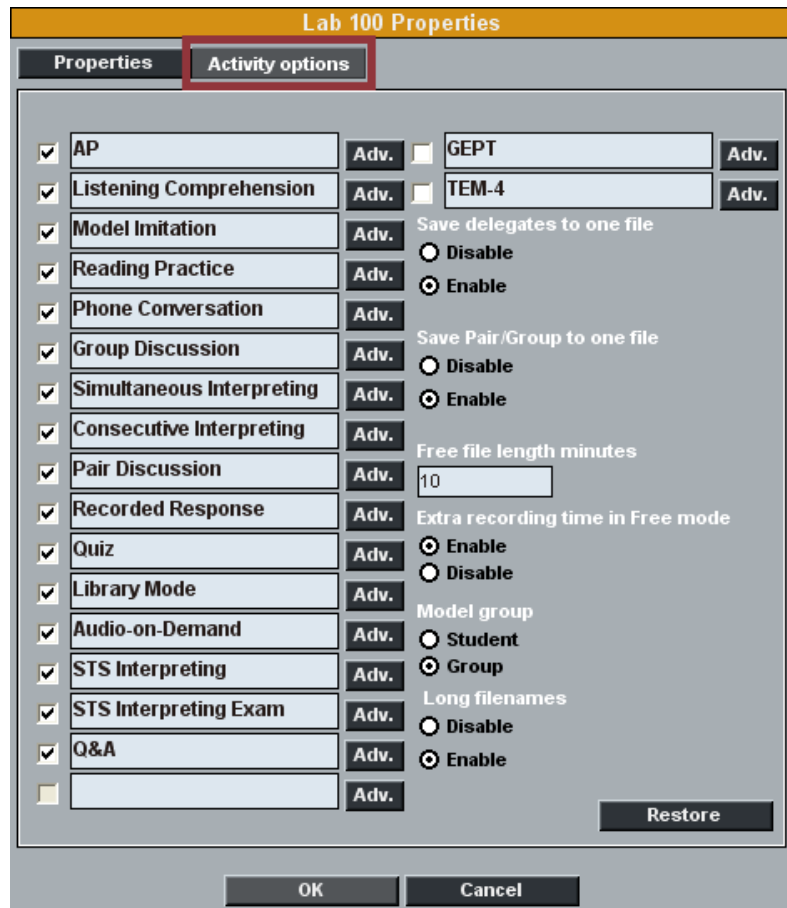

- **To rename an activity**, click on the activity name field and enter a new name for the activity.
- **To select which activities are displayed** in the **Activity selection** list, check or uncheck the boxes next to the activity names.
- **To edit the default recording settings of an activity**, click the **Adv.** button next to each activity

- **To restore the original activity settings**, click on the **Restore** button.

### ***SAVE DELEGATES TO ONE FILE***

This option only affects Lab 100 STS. When enabled, delegate recordings will be collected as a single file in Lab 100 STS interpretation activities. When the option is disabled, separate files will be created for each delegate, however, each file will have the entire delegate discussion as the content.

### ***SAVE PAIR/GROUP TO ONE FILE***

This option allows you to choose whether you want to save student recordings to a single file or into separate files for each student during pair and group discussion activities.

When enabled, only one file will be saved of each pair or group discussion. When the option is disabled, separate files will be created for each discussion participant, however, each file will have the entire pair/group discussion as the content.

### ***FREE FILE LENGTH (MINUTES)***

This option allows you to define the length of time in minutes that students will be able to record when their recorders are in **Free** mode. The maximum recording time is 99 minutes.

### ***EXTRA RECORDING TIME IN FREE MODE***

In activities where the student tracks are recorded and students work with the program material in Free mode, enabling this option will allow students to continue recording after the program track has ended.

This is particularly useful, for example, in the Model Imitation activity as instructors can play program material without recording gaps on the first listen and then let the students go through the material and record their output at selected places.

### ***MODEL GROUP***

When you have a session that is in either Pair or Group Discussion, you can use a student or a group from that session as the audio source for another session. **Model Group** defines whether an individual student or a group will be used as the source in these cases.

### ***LONG FILENAMES***

Enabling long filenames inserts additional information to filenames when student recordings are saved. When long filenames are enabled, saved recordings are named in

normal Lab 100 activities as follows:  
"[name/number\_scuport\_date].[file format]"

In Lab 100 STS interpretation activities delegate and interpreter recordings are named as follows:  
"[name/number\_delegate/interpreter\_date].[file format]"

When disabled, normal file naming will be used:  
"[student name].[file format]"

---

Note: If a collection folder for student tracks has been defined in My Settings and the **Long filenames** option is enabled, Lab 100 will not prompt you for a subfolder name before collecting student recordings. Instead it will automatically create a new subfolder, which is named in the following manner: 'yyyy\_mm\_dd\_hhmm' (year\_month\_date\_hour and minute).

---

## SELF-ACCESS SETUP

Self-access setup opens a window in which you can select the MSU files that will be available for the self-access student workstations.

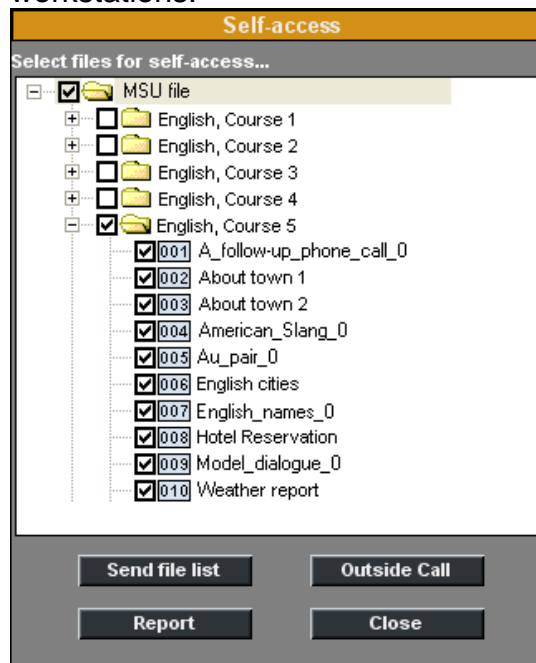

Self-access workstations can be used for independent study outside teacher control and they are defined in the Lab 100 Config application. For more information, see the chapter *Setting up self-access workstations* in the Lab 100 Setup section of this guide.

To select the MSU files available for self-access workstations:

1. Tick the boxes next to the files to select them. Ticking a folder will select all the files in the folder, but not in its

subfolders. When selected, a number appears next to the files, according to which the students will be able to select them for listening.

2. Click on the **Send file list** button. This makes the files available to the self-access students and they can then listen to the files by entering the file number on their UAP.

To talk to the self-access workstations, click on the **Outside Call** button.

The easiest way provide self-access students with information on which files are available to them is to have a print-out of the file list next to the self-access workstations. To open a printable list of the files that are available for self-access students, click on the **Report** button.

## PODCAST MANAGER

The Podcast Manager allows you to manage podcast files and to create new RSS Feeds on the podcast Web pages.

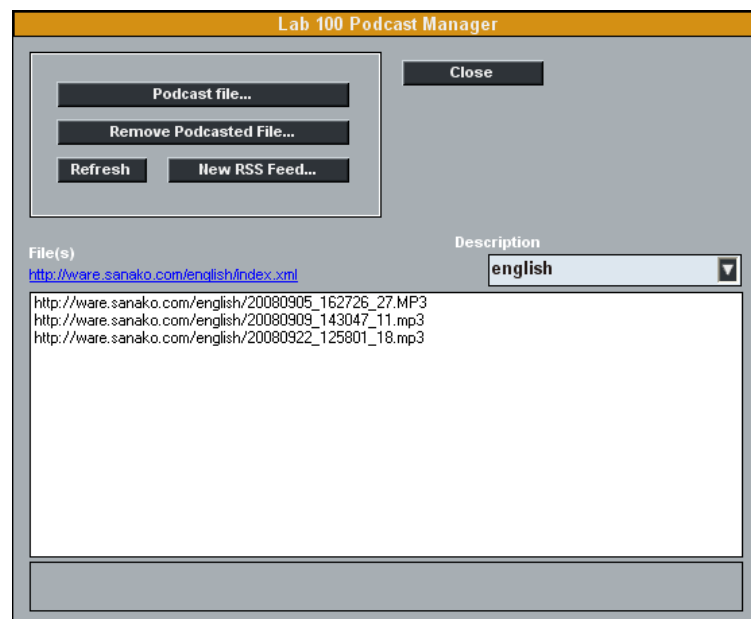

The Podcast Manager displays all the podcast files in the selected remote directory. You can change the remote directory that is viewed with the **Description** drop-down list.

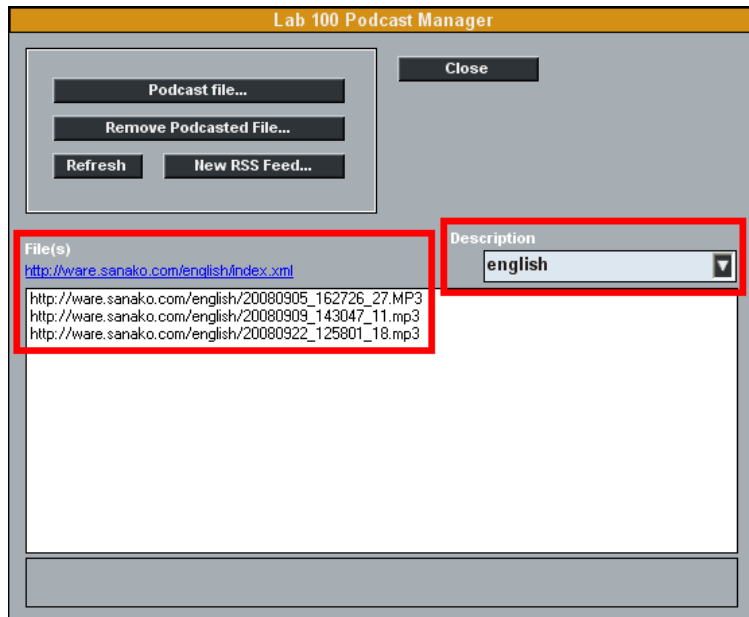

Please note that before you can podcast audio material in Lab 100, you need to

1. Configure a Web server to host the podcasts. See *Properties - Podcast options tab* under *Lab 100 main menu*.
2. Create remote directories for the podcasts. See *Properties - Podcast options tab* under *Lab 100 main menu*.
3. Create RSS feeds for the remote directories. See *Podcast Manager* under *Lab 100 main menu*.

### **PODCASTING A NEW FILE**

To create a new podcast out of a media file

1. Click the **Podcast file** button. This opens a dialog where you can select the file to be podcasted.



2. Click **Browse** and select the media file to be used for the podcast.
3. In the **Description** field, enter a description of the file content. This description will be displayed on the podcast Web page
4. Enter a **Title** for the podcast. This title will be displayed on the podcast Web page.

5. Click **OK**. Once the file has been uploaded, a dialog will appear displaying the Web address where the podcast is now available

### **REMOVING PODCAST FILES**

To remove a podcast file, select the file in the Podcast Manager window and click **Remove Podcasted File**. The file will be removed from the podcast manager view, the podcast Web page, and the Web server.

### **CREATING NEW RSS FEEDS**

Creating an RSS Feed for a remote directory allows students to be automatically notified when new podcasts are available on the podcast Web page for the remote directory in question. Students can subscribe to the RSS Feed while visiting the podcast Web page.

For information on creating Web pages and remote directories for podcasting, see *Properties - Podcast options tab* under *Lab 100 main menu*.

**To create a new RSS Feed** for a remote directory, click the **New RSS Feed** button. In the dialog that opens, enter the required information for the feed

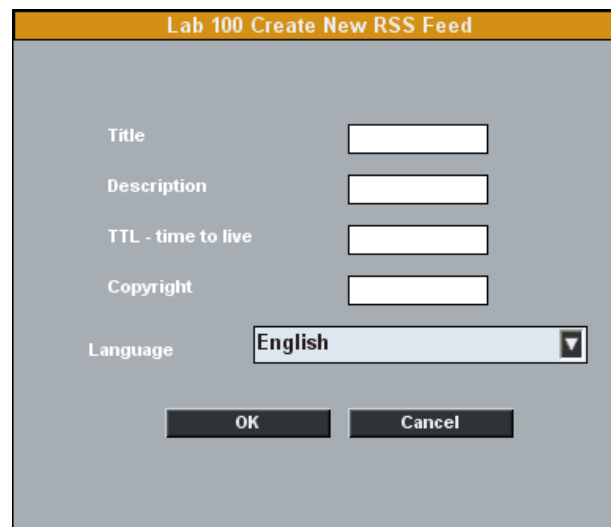

- **Title** – Enter a title for the RSS Feed. This will be displayed on the podcast Web page.
- **Description** – Enter a description for the RSS Feed. This will be displayed on the podcast Web page.
- **TTL** – Define (in minutes) how often the podcast clients, with subscriptions to the podcast feed, will check if there is new content on the web page
- **Copyright** – Enter the podcast copyright holder. The copyright holder will be written into the podcast Web page .xml file.

- **Language** – Enter the language of the Podcast

When you have entered all the information for the new feed, click **OK**. The feed will now be displayed on the podcast Web page and students are able to subscribe to it.

## RESET WINDOW POSITIONS

To set the default position where the student monitoring windows will be opened, left-click a student icon and then drag the window to the desired position.

All student monitoring windows will then open in the same position until the Lab 100 application is closed. You can reset the default position by selecting **Reset Window positions**.

## ABOUT...

Selecting **About** opens a window displaying version information on the different Lab 100 components, as well as the total and remaining MSU capacity.

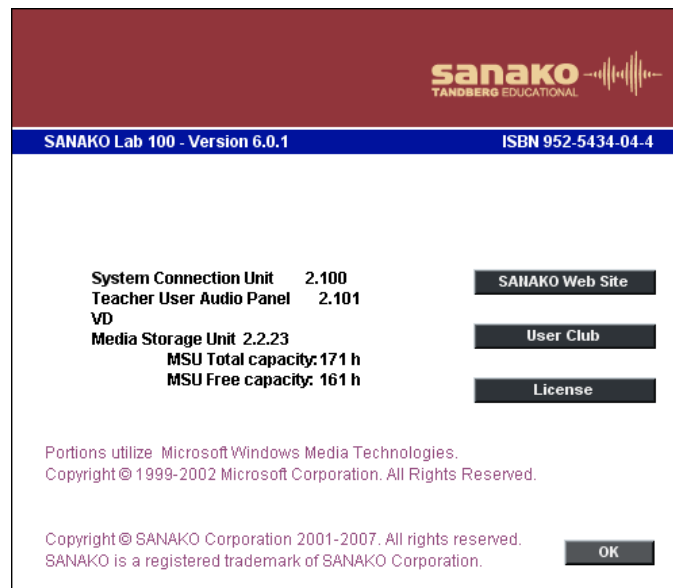

## EXIT

Selecting **Exit** closes the Lab 100 interface and exits Lab 100.

If the students are in the Audio-on-Demand activity when you exit Lab 100, you can choose to leave the student audio panels on to allow the students to continue working with the Audio-on-Demand material.

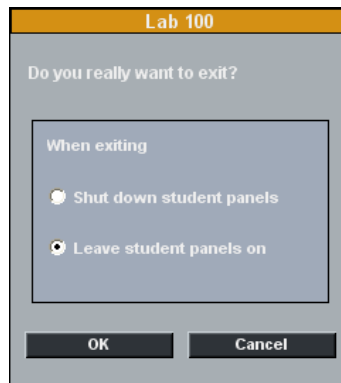

Select one of the options, and click **OK**.



# SEATING PLAN

Seating Plan is a class setup, where the student's name is associated and displayed with each position icon. The class setup stays in the computer memory, so once you have created one, you can easily retrieve it whenever the class meets. The data in the Seating Plan is easily edited, when changes are necessary.

## CHOOSING A SEATING PLAN



1. On the toolbar, click the **Seating Plan** button to select a setup for your class. The following drop-down menu opens.

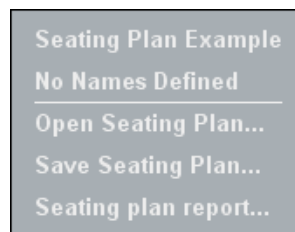

*Seating Plan drop-down menu*

2. Select **Open Seating Plan** to open the Seating Plan folder.
3. Choose a desired seating plan.

To select a seating plan where the students are not yet named, select **No names defined**. To name the students, click the **Attendance** button. (See the following chapter *Attendance*).

Selecting **Seating Plan Example** opens an example seating plan with fictitious student names.

→ For more information about naming the students, see the next chapter *Giving a new name*.

After you have created and saved a seating plan, the named seating plan is added to the drop-down menu. You can from now on retrieve the seating plan whenever you need it, by selecting it on the menu.

## SETTING A DEFAULT SEATING PLAN

You can select any one of the created seating plans as the default seating plan. The default seating plan will then be loaded automatically when Lab 100 is started. To define the

default seating plan, see *Default Seating Plan* in *My Settings* - *Properties* tab in the Lab 100 Menu.

## CREATING A SEATING PLAN FOLDER

You can create a folder for the seating plan file of each class or group you are teaching. Categorizing the seating plan files by creating folders and subfolders facilitates the search for a specific seating plan.

For example, you can create a folder where you save the seating plans of all the groups you are teaching (*Teacher Mary Smith*). Additionally, you can specify the categories by creating a folder for groups of one specific subject (*Teacher Mary Smith: French*), and finally, you can name and save the seating plan file of each French group in the created folder (*Teacher Mary Smith: French: 4b*).

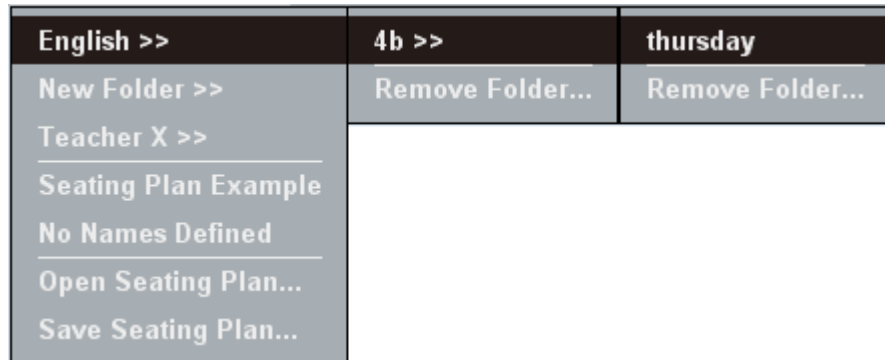

The Seating Plan menu with subcategories

## TO CREATE A SEATING PLAN FOLDER

1. To create a seating plan folder, in the Seating Plan menu, select **Save Seating Plan....** The following dialog box opens.

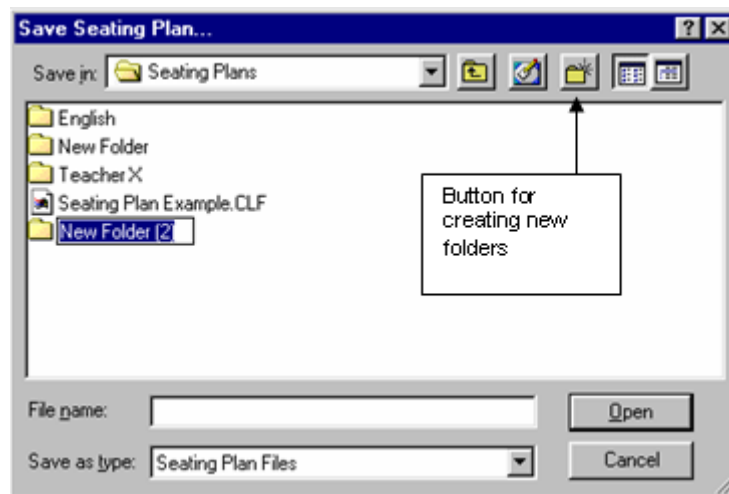

2. In the dialog, click the **Create New Folder** button . A new folder appears in the dialog. You can now name the folder.

## OPENING A SEATING PLAN FOLDER

In the Seating Plan menu, select **Open Seating Plan....** In the dialog that opens, select a folder and click **Open**.

## REMOVING A SEATING PLAN FOLDER

1. In the Seating Plan menu, point the name of the folder you want to remove.
2. Point and click **Remove folder**. The following dialog opens.

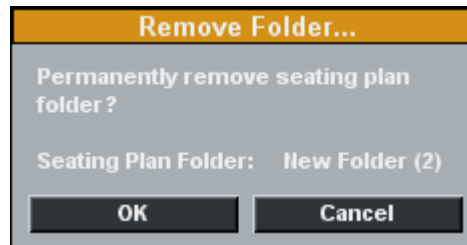

3. To confirm the removal, click **OK**.

Note that if the selected folder contains subfolders, also the subfolders will be removed.

-Or-

1. In the Seating Plan menu, select **Open Seating Plan**.
2. In the dialog that opens, select the folder to be removed (click on the folder name).
3. On the name of the selected folder, press down the right mouse button.
4. From the menu list that opens, select **Delete**.
5. To confirm the removal, click **Yes**. Note that if the selected folder contains subfolders, also the subfolders will be removed.

## ABOUT MODIFYING THE DEFAULT FOLDER

The default folder for saving and opening seating plan files is set in the Configuration program. To change the default folder, in the Configuration program, click **Set default settings** and in the Lab 100 Properties dialog that opens, modify the folder as appropriate.

## REMOVING INDIVIDUAL SEATING PLANS

1. In the Seating plan menu, select **Open Seating Plan**.
2. In the dialog that opens, select the file to be deleted. If the file is inside a folder, open the folder to view the appropriate file.
3. Right-click on the name of the file to be removed.
4. From the menu list that opens, select **Delete**.
5. Click **Yes** to confirm.

## SEATING PLAN REPORT

To view a report of the current seating plan, select **Report** in the Seating plan menu. This opens a window displaying your current seating plan setup that you can print or save for later reference.

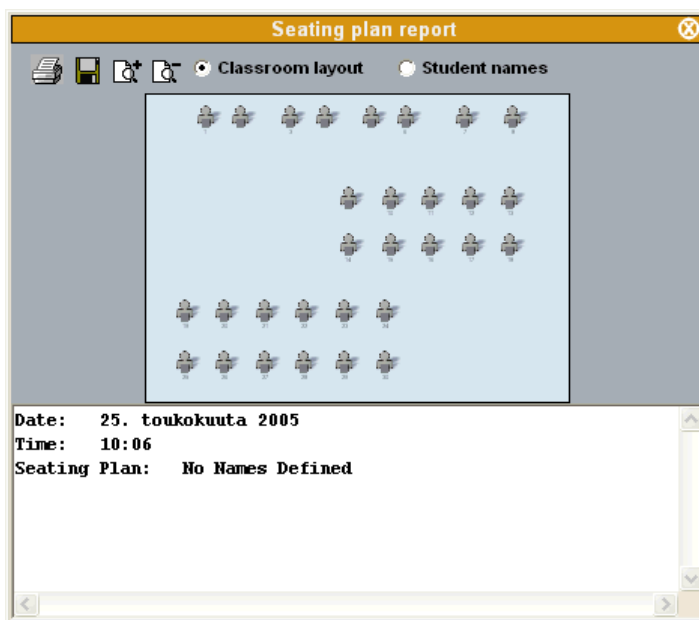

To view the arrangement of student icons, select **Classroom layout**.

To view a list of the students in the seating plan, select **Student names**.

# ATTENDANCE



Clicking the **Attendance** button opens a menu allowing you to mark off the student positions that are not used during the class, to name or rename students and to enable or disable the student login function.

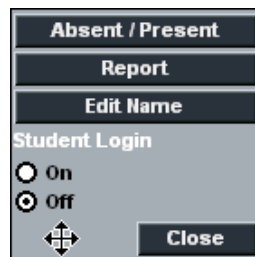

## TAKING ATTENDANCE

Once you have marked a student position absent, the icon of that student is disabled. So you don't have to worry about accidentally selecting that position during activities.

In Pair and Group Discussion, when forming pairs or groups, the absent-marked students are not included in the selection.

Additionally, when using the automatic monitoring feature, it is useful to have the absent students' workstations marked, since that way the monitor doesn't make any unnecessary stops at workstations that are not in use, but skips them and moves straight to the next active student workstation.

→ The automonitoring feature is explained under *Automonitor*.

### TO MARK THE ABSENT STUDENTS' WORKSTATIONS

1. On the toolbar, click the **Attendance** button. The following menu opens.

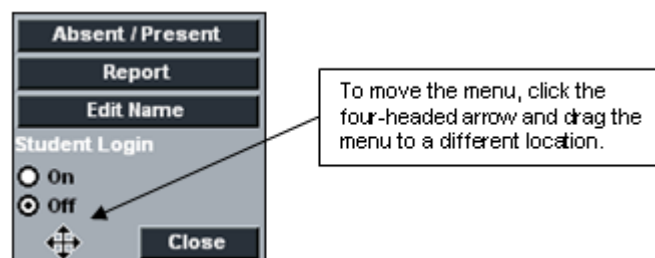

Attendance drop-down menu

2. In the menu, click the **Absent/Present** button.
3. Select then a student or several by clicking on the student icons one by one, or by dragging the mouse pointer the

left mouse button pressed down over the icon(s). The absent student's icon is disabled.

4. To mark a student present, follow the steps from 1 to 3. The student icon becomes active.

## STUDENT LOGIN

If **Student Login** is **On**, students have to press the **Call Teacher** button on their student panels at the beginning of a lesson. This will activate their student icons on the teacher interface. All other student icons will be handled as absent. When you start Lab 100, the following message will appear indicating that Student Login is enabled.

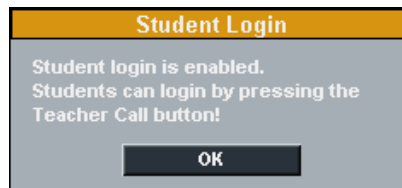

When **Student Login** is **Off**, all workstations are automatically active at the beginning of the lesson.

However, regardless of whether student login is on or off, the **All Call** function is always active to all student workstations.

## ATTENDANCE REPORT

Selecting **Report** from the Attendance menu opens the Attendance Report window.

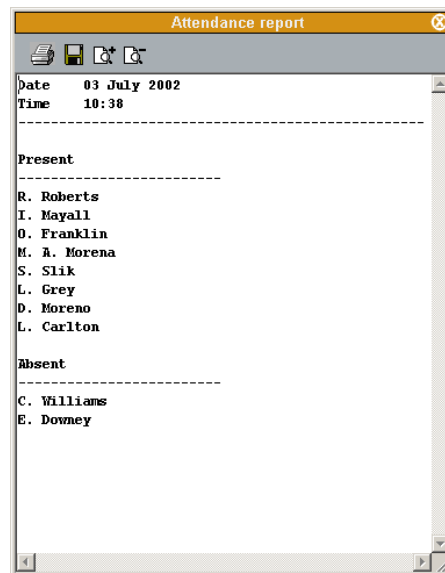

*Attendance Report window*

In the report, you can view the report date and time, and thus all the students listed according to whether they are present or absent.

By clicking the appropriate control buttons you are able to save the report to your computer or anywhere in the network and print it out. Additionally, you can zoom the window in or out to decrease or increase the font size, and scale the report to fit the sheet you want to print it on.

### ***ABOUT PRINTING THE ATTENDANCE REPORTS***



You can print the report by clicking the printer symbol on the upper left corner of the report window. The report is printed to the Windows default printer.

In the Attendance Report window, clicking the print command button opens a print settings dialog before starting to print. For example, you can change the destination printer if appropriate.

### ***SAVING THE REPORT***



By clicking the disk symbol on the upper left corner of the window, you can save the report to your computer or anywhere in the network.

### ***ZOOMING IN AND OUT THE REPORT VIEW***



Note that the font size in the printed report is the same as the one seen on your screen. To zoom the font size in or out, click the symbols on the upper part of the report window. If you zoom the report in or out and print it out, the font size of the print is changed accordingly.

### ***ADJUSTING THE REPORT VIEW***

The print sheet scales automatically on your screen; to fit the whole report to the sheet you want to print on, you may want to enlarge the report window.

To change the size of the report window, click on a side or a corner of the window, and the mouse button pressed down drag the side or corner to adjust the window size as appropriate.

### ***CLOSING THE REPORT WINDOW***



To close the report window, click on the symbol in the upper right corner of the window.

### **REPORT WINDOW TOOLTIPS**

In the Attendance report window, when you move the mouse pointer over a control button, a tooltip text appears telling you what each button on the toolbar does.

### **GIVING A NEW NAME**

1. On the toolbar, click the **Attendance** button.
2. In the menu that appears, click on the **Edit name** button.
3. Click then on the icon of the student, to whom you want to give a name or whose name you want to change. The student's name appears in a field where it can be modified.
4. When you have given or modified the name, click **Close**, press Enter or click on the next student icon.



# NEW SESSION

The **New Session** button is for creating a Lab 100 session. Clicking this button opens the Session Screen, where you create and control the session.



## SELECTING STUDENTS FOR A SESSION

There are three ways to select one or several students for a session.

1. Click the **Add/Remove** button, and then the icon of the student you want to select.

To select the students by dragging the mouse pointer:

2. Click the **Add/Remove** button, and move the mouse pointer, the left mouse button pressed down, over the student icons.

To select all the students that not yet are in a session:

3. Click the **All Remaining** button.

## REMOVING A STUDENT FROM A SESSION

You can remove students from a session in the same way you select them for the session.

1. Click the **Add/Remove** button, and then the icon of the student you want to select.

Or by dragging the mouse pointer over the icons:

2. Click the **Add/Remove** button, and drag the mouse pointer, the left mouse button pressed down, over the student icons.

## ACTIVITIES IN THE LAB 100 SESSIONS

The Lab 100 language learning center is based on a variety of learning activities. Each learning activity has its own specific characteristics, which you can see on your screen: The controls that appear on the Session Screen depend on the activity that you select.

The general procedure is the same for every activity, but for each specific activity only the controls that are necessary for completing that particular activity appear.

### ***LISTENING COMPREHENSION***

Students listen to questions on the master track and then respond to them in order to develop their listening skills. You may allow students access to their recorders, so that they can work with the source individually, at their own pace. While or after listening to the source, you can call the session, and select a student or several to answer questions.

### ***MODEL IMITATION***

By listening to a model audio and repeating after, the students practice the stress, rhythm and intonation of the foreign language. You can use yourself or a student as the model audio for the session. You can allow the students to access their recordings, and can monitor and comment on their individual work.

### ***READING PRACTICE***

In order to practice, for instance, pronunciation and intonation. Students read aloud and listen to their input. If allowed, students can work individually and at a speed they are comfortable with, and they can listen to and record their reading over and over again.

### ***PHONE CONVERSATION***

Students practice speaking on the phone, by calling each other through their audio panels. If the program source is used, the student can hear the program only when they are calling each other. The teacher can monitor and comment the pairs' work.

### ***PAIR DISCUSSION***

In pairs, students develop their rhetorical skills through different oral exercises. They can focus on using their own words instead of fixed structures and learn together at a speed they are comfortable with. You can select the pairs yourself or have the program make up random or fixed pairs for you.

### **GROUP DISCUSSION**

Working in groups, students can practice speaking skills through role-plays as they express ideas and opinions, and defend a point of view. Students can, for instance, learn to understand and react appropriately in situations where intercultural communication is involved. Setting up groups is quick and easy, and you may change the groupings at any time.

### **SIMULTANEOUS INTERPRETING**

You will select an audio source that the students interpret simultaneously into their native language. For example, you can select yourself as the audio source and read the students aloud. Students interpret as you read, and the student input is recorded for later evaluation. You can allow the students to listen and rerecord their input and monitor them as they practice.

### **CONSECUTIVE INTERPRETING**

Consecutive interpreting means that the source is interpreted into another language in sections. The speaker stops at the end of every 'paragraph', and the interpreter then interprets what was said. You may allow students to rerecord their input individually and monitor them as they practice.

### **RECORDED RESPONSE**

Ideal for training the intercultural communication through situational exercises. For example, students simulate a job interview with a prerecorded source and focus on reacting appropriately.

### **QUIZ**

The Lab 100 Quiz is a quick and easy way to see how well the students answer the questions you ask. You access the test response modes and immediately get an indication of the effectiveness of your teaching and retention of the concept.

### **AP® EXAM**

With Lab 100 you can accomplish also externally certified activities, such as AP oral exams. Lab 100 is specially designed to set up, test and collect student AP aural responses. The Lab 100 student audio panel provides a quick, easy and efficient exam vehicle.

### **GEPT**

GEPT (General English Proficiency Test) is a standardised English language test in Taiwan. The Lab 100 GEPT activity

provides a simple and organised method of delivery for the GEPT exam and guides teachers through the exam process.

### **TEM-4**

TEM stands for Test for English Majors and it is a standardised English test used in China to test students' college-level proficiency in English. The TEM-4 activity allows teachers to deliver certified TEM-4 tests using Lab 100.

### **Q&A**

The Q&A activity allows you to train students' oral skills by playing them an audio source and then pausing it when you want them to answer a question. The students' answers are automatically recorded.

### **LIBRARY MODE**

Library Mode is an activity that allows you to assign audio files to students for their individual work. You can send the same file to every student, or a different file for each. Even if the students all have the same file, they will still be able to work with their copies of it individually. After the students have performed the test or another exercise, you can save the outcomes for later use.

### **AUDIO-ON-DEMAND**

The Audio-on-Demand activity allows you to assign audio files or an external program source for students' individual work. You can decide who will have access to which audio material, if any. The audio material can be made accessible to the selected students, for example, in a folder, on an audiocassette, or on an audio CD. At the end of the session, the student recordings can be collected

→ For step-by-step instructions on how to set up and proceed with the different activities, see the *Activity Procedures* section of this guide.

# AUDIO CONNECTIONS

## RECORDINGS

You have total control of the student audio panel regardless of the activity. Default settings for each activity match the task, but may be changed to select or deselect the recording function for each or both the master and student track(s).

In the table below, you can see the default recording settings for each activity.

| Activity                  | Master Track | Student Track |
|---------------------------|--------------|---------------|
| Listening Comprehension   | λ            | ○             |
| Model Imitation           | λ            | λ             |
| Reading Practice          | ○            | λ             |
| Phone Conversation        | ○            | ○             |
| Pair Discussion           | ○            | ○             |
| Group Discussion          | ○            | ○             |
| Simultaneous Interpreting | λ            | λ             |
| Consecutive Interpreting  | λ            | λ             |
| Recorded Response         | ○            | λ             |
| Quiz                      | ○            | ○             |
| AP® Exam                  | ○            | λ             |
| GEPT                      | ○            | λ             |
| TEM-4                     | ○            | λ             |
| Q&A                       | λ            | λ             |
| Library Mode              | ○            | λ             |
| Audio-on-Demand           | ○            | λ             |

λ = the track is recorded

○ = the track is not recorded

In activities such as Listening Comprehension, Model Imitation and Simultaneous and Consecutive Interpreting, in which the audio source plays an important role, the program defaults for recording the master track.

However, in some activities, no audio source and therefore no master track recording is needed at all (Pair, Phone and Group Discussion). In Recorded Response both the audio source and the student output are recorded to the student track, and in AP® Exam, only the student track is recorded.

### **RECORDING THE MASTER TRACK**

Recording the master track means recording the session's audio source to the Media Storage Unit, file server, or your computer. If the source is one of the students or yourself, the student's/your voice is recorded to the master track.

When the master track is recorded, you can use the recorded track over and over again. For example, you can allow students to work with the track individually, without having to control it from the teacher console.

In Session Call and All Call, if the recording of the master track is on, your voice is not recorded on it while calling the session/class. Student Call is never recorded.

→ For more information about the MSU file, see chapter *MSU File* in the *Audio Connections* section of this guide.

### **RECORDING THE STUDENT TRACK**

Recording the student track means that from the initiation of the activity onwards, everything the student says is recorded to the file server or to your computer.

In intercom, your comments are recorded to the student track. Responding to a student's call functions as the intercom connection.

→ For more information about the MSU file, see chapter *MSU File* in the *Audio Connections* section of this guide.

### **CHANGING THE DEFAULT OPTIONS**

You can change the recording settings in the **Activity Options** panel.

→ On how to change the recording settings, see the description below *Activity Options*.

## ACTIVITY OPTIONS

In the Session Screen, below the field for selecting the activity, there is a button for advanced activity settings.



*The part of the Session Screen where you select the activity*

### **ADVANCED...**

When you click the **Advanced...** button, a panel for setting recording options for the current activity opens. In the panel, you can change recording and sidetone settings by marking or unmarking the boxes accordingly.

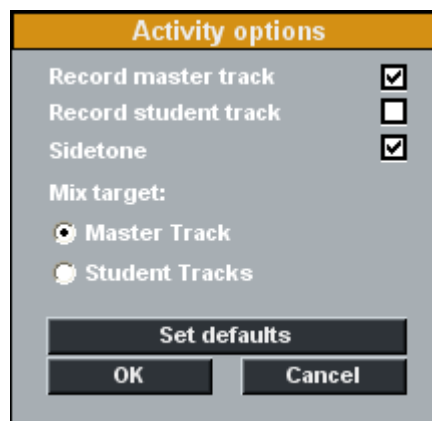

*Panel for setting the recording options*

### **RECORD MASTER TRACK**

Recording the master track saves the sound from the master track. You can record the source to the master track for later use or for the student's to work with it individually later.

### **RECORD STUDENT TRACK**

Recording the student track saves the student track input. While the master track is playing, the students can record their own speech on the student track. For example, the students can repeat after the master track, answer questions, or practice simultaneous interpretation. If you record the student track, you and/or your students can listen to the track later.

### **LENGTH OF THE STUDENT RECORDING**

In Free mode, if the source the students are working with is other than an MSU file, the program prompts you to define the time the students are able to record their output.

When you are working with an MSU file, the time given for student output is the same as the length of the file.

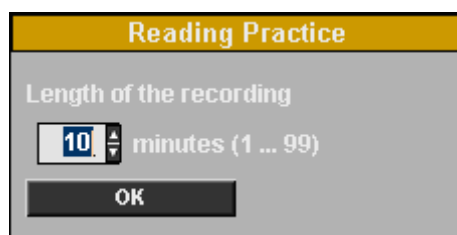

To define the recording time, enter the file length (1 ... 99 minutes) in the field and click **OK**. The maximum recording time is between 1 ... 99 minutes and the default value can be set in Lab 100 Config application.

### ***RECORDING BOTH TRACKS***

If you select both the tracks to be recorded, both the master track output and the student input are saved separately.

### ***SIDETONE***

Sidetone means that the students hear themselves as they speak. If you want to silent the student's voice, leave the box empty. For example in simultaneous interpreting, it is important that one's own voice doesn't mix with the source.

### ***MIX TARGET***

Teachers can record their voice during a program transfer with the **Mix** button in the Activity panel. The **Mix target** options allow you to select whether the teacher's voice will be recorded to the Master or Student track when they use the Mix function.

### ***SET DEFAULTS***

Each activity has their own default settings. You can return the default settings of the activity by clicking the **Set Defaults** button.

After you have marked or unmarked the desired recording options, click **OK**.

## **AUDIO SOURCE**

In the Lab 100 sessions, your audio sources include any digital media you access through your computer, plus auxiliary sources, such as MP3 players, CD Audio players and audio / video cassette players which you connect through the Audio source interface. This means that you can benefit of all kinds of audio materials in your classes.



All sources except an MSU file are controlled separately. An MSU file is controlled via your GUI, which means that starting an activity starts the playback of the file.

Additionally, you can select yourself or one of your students as the audio source for the session.

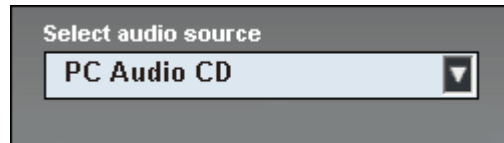

*The part of the Session Screen where you select the audio source*

The variety of audio sources is set in the installation and it depends on the devices that are available in your class. Possible Lab 100 audio sources are:

- Media File
- MSU File
- PC Audio CD
- Student
- Teacher
- Teacher PC
- Line In (external sources: VCR, DVD, Cassette, MP3 Player, etc.)
- Program Source Interface (external sources: VCR, DVD, Cassette, MP3 Player, etc.)

To select an audio source, select the source from the list that opens by clicking on the field. The necessary window(s) and control(s) appear for the source.

## **MEDIA FILE**

A media file is a digitized audio and/or video file (for example in WAV, AVI, MP3 format) saved on the hard disk of your computer or server.

Selecting a media file as the audio source opens the **Select Media File** window. In the window, browse for the media file you want to select as the audio source.

The associated player is launched. Note that the player can be changed through standard Windows associations.

Prior to sending a media file to the students for their individual work, you can playback and record it to the Media Storage Unit. Or as it is played, it can be recorded on Master Track and then saved in the Media Storage Unit. This allows for it to be directly integrated into activities in future sessions as an MSU file; no separate player is then needed.

To avoid feedback noise, the Line In option is automatically muted in the Windows mixer, when a Media file is used as the program source.

## MSU FILE

An MSU file is a .WAV format file that is located in the Media Storage Unit (MSU). This means that you can either use it as a source, or send it directly to the student audio panels for the students' individual work. If your source resides in the MSU, you can use the file from there and you don't have to create a separate master track first.

Note that the students are not able to make any changes to an MSU file.

Selecting an MSU file as the audio source opens the **Select Media File** window. In the window, browse for the media file you want to select as the audio source.

### CREATING AN MSU FILE

There are two ways to create an MSU file:

1. You can copy media files from your computer to the Media Storage Unit (MSU) and back onto your hard disk.

-Or-

2. Make sure the master track of the session is recorded during the activity. When exiting the session, the program will ask you if you want to save the master track for future use. Select Yes, and give the track a name. The track is saved to the MSU.

Once you have saved a file to the MSU, you can use it from there by selecting **MSU File** as your audio source.

### USING MSU FILES AS SOURCE

In the audio source list, select **MSU file**. You can select an MSU file for two sessions only. Below the audio source field appears the **Controls...** button. Clicking the button opens the following window for MSU controls.

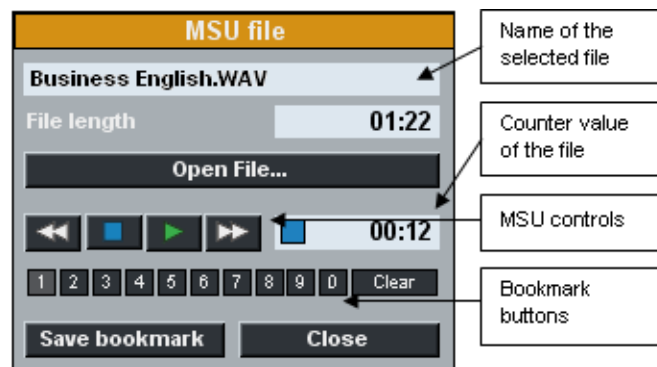

MSU controls window

In the window, click **Open File...** button to browse for the file you want to use as the audio source.

The controls for an MSU file are rewind, stop, play and fast-forward.

Next to the controls is a real time counter for the file. You can also set and clear bookmarks.

Clicking on the **Save bookmark** button will save the set bookmarks and they will be automatically available the next time that a teacher or student opens the MSU file.

To close the window, click **Close**.

### ***FILE LAUNCH IN STUDENT POSITIONS***

You can launch a file in a student position, so that the student can work with it individually. To launch a file, do as follows:

1. Browse for an MSU file and open the file.
2. Play the file by using the MSU controls in the Session Screen. You can also set bookmarks to the file by clicking the bookmark buttons in the controls window. The bookmarks remain in the file as it is launched in the student position, i.e. the students work with the file containing the bookmarks you have set.
3. To launch the file, click the **Free** button.

### ***EDITING THE AUDIO SOURCE***

When your audio source is an MSU file, you can edit the source while you and the students are listening to it. This means that you can communicate to the students without having to manually pause or stop the audio source and the recordings from a separate player. When you edit the source, the source is paused and your voice is connected to the students and recorded to the master track. By editing the source you can later listen to and save the comments you made during the activity.

To edit the source, click the **Edit** button under the audio source field. The original audio source stops, your microphone is connected to the students and your voice is recorded to the master track.

To continue with the original audio source, click the button again. Your microphone is disconnected from the students and the students now hear the selected source again.

### ***MIXING THE AUDIO SOURCE***

When your audio source is an MSU file, you can mix the source while you and the students are listening to it. This means that you can record your voice to the students while

the audio source is playing. When you mix the source, your voice is connected to the students and recorded to either the master or student track. You can select the target track in the activity options, which are available when you click the **Advanced...** button. By mixing the source you can add comments and instructions to the students while the program is being transferred.

To mix the source, click the **Mix** button under the audio source field. The original audio source will continue playing while your microphone is connected to the students and your voice is recorded to either the master or student track.

To end recording your voice, click the button again. Your microphone is disconnected from the students and your voice is no longer recorded during the program transfer.

## PC AUDIO CD

The PC audio CD source allows you to play audio CDs with the teacher computer CD player. After selecting PC Audio CD, click the Controls button to open a CD player window.



The CD is controlled manually with the CD player controls during the activity.

## STUDENT

Selecting a student as the audio source for the activity means that the selected student's microphone opens and the student is the source for all the students in the session. To select a student as a source, proceed as follows:

1. Select the **Student** from the audio source list.
2. Click the **Select Student** button, and click then the icon of the selected student.

You can also select a student, a pair, or a group from a session that is in Pair or Group Discussion as the audio source for another session the same way. Whether a single student or the pair/group that the selected student is in will

be used as the audio source in these cases can be defined in the Lab 100 Properties window under Model group.

## TEACHER

You can select yourself as the audio source for the session. For example, you can read a text aloud and have the students repeat after it.

## TEACHER PC

All audio that is played on the teacher computer is transferred as the audio source. However, audio that goes through the teacher User Audio Panel is not sent to students.

For example, teachers may select the Teacher PC audio source and then play back audio from Internet sources to students.

## LINE IN

Line In means connecting individual audio sources to students. The source can be any kind of analog audio source, and each student hears the source that is connected to his or her own audio panel.

In Pair and Group Discussion, the students share all the sources that are connected to the audio panels of the pair or group.

## VIDEO AUDIO

Once the configuration of the external video source is completed, you can use video material as audio source for the session. To use the video as program source, do as follows:

In the graphical user interface of Lab 100, in the Source menu list, select the video option.

In the Source menu list are displayed all the sources that were defined in the **Video Sources** dialog. When the menu item is selected, you can view the video on your screen and hear the audio in your headset.

To display the video source to the students in the session, click Start. The session students are now able to view and hear the video.

If you have started a different video for different sessions, the video that is played on your screen and headphones is the one that the students in the currently active session are viewing and hearing.

By switching from one session to another (by clicking the session tab accordingly) you can see and hear the video that the students of the corresponding session are seeing and hearing. That is, when you move from one session to another, if the sessions have different video sources, the video source on your workstation changes accordingly.

To stop the video transfer on the student screens, click Pause or End.

## MONITOR AND INTERCOM

Monitoring a student means listening to a selected student's work. Left-click on a student icon, and you will instantly hear what the student is saying and hearing. In the intercom connection, you can monitor and speak with a student.

In Pair / Group Discussion and Phone Conversation, the monitor and intercom connection cover both of the pair members / the whole group.

### MONITOR

You can monitor the student at any point by clicking on the student icon (left mouse button). Clicking on the student icon opens the following panel.

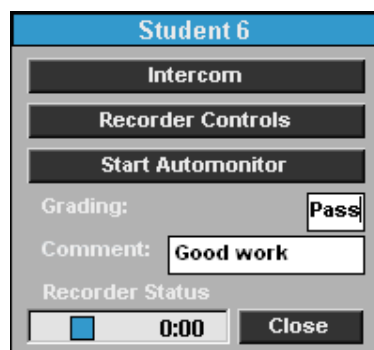

*Monitoring panel*

On the monitoring panel, you can see the student's recorder status and counter value, as well as the student's current grade. If the student has not been graded you can type in a grade in the Grading field, as well as a comment in the Comment field. The monitoring panel also allows you to access the intercom and automonitor modes.

To stop monitoring, click the **Close** button, or anywhere on the class view.

To change the location of the monitoring panel, simply click on the title bar, and drag the panel to other location. All student monitoring windows will then open in the same position until the Lab 100 application is closed. To reset the

default position, select **Reset Window positions** in the **Menu**.

## INTERCOM

Intercom means that you can participate in one student's or several students' work. The intercom is an interactive connection between you and the student(s); the students hear your voice and are able to reply. In the intercom connection, your voice is mixed to the audio source. If recording is on, your voice is recorded to the student track.

This functionality is useful especially in pair or group discussion, since you can join the pair or group's work at any point of the exercise. In Pair or Group Discussion, also the pair or group members of the selected student are included in the intercom connection.

### TO INTERCOM

To establish an intercom connection, do as follows:

1. Click on a student icon. A panel for monitoring the student opens.

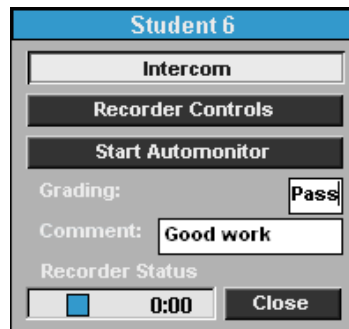

*Monitoring panel*

2. There are two ways of establishing the connection:
  - a) In the monitoring panel, click the **Intercom** button.
  - b) In the monitoring panel, click the **Recorder Controls** button. A replication of the student's audio panel opens in the Session Screen. In the Session Screen, click the **Intercom** button.
3. When the connection is established, the student icon changes accordingly and the red-highlighted On the Air sign is lit.



4. To disconnect, click the **Intercom** button again (whether in monitoring or Session Screen). Alternatively, you can click the **Close** button, or anywhere on the class view. These also close the panel.

## INTERCOM AND MODEL STUDENT

When a model student is chosen as the audio source for the session and you use the Intercom function, all students in the session are able to hear both your and the model student's voice.

## INTERCOM AND FREE MODE

Using the Intercom function when the students are in Free mode stops the students' recorders automatically.

## RECORDER CONTROLS

On the monitoring panel, clicking the **Recorder Controls** opens a view of the monitored student's audio panel.



*Replication of the student's User Audio Panel*

## AUTOMONITOR

An easy way of monitoring all the present workstations is the automonitoring scanning mode, where all the present workstations are monitored automatically and consecutively.

You can select the amount of monitoring time. The icon of the monitored student reflects which student is being monitored at a time, and shows a replication of the monitored student's audio panel on the Session Screen.

If you have marked the absent students' workstations when taking attendance, the monitor doesn't make any unnecessary stops, but skips the unused workstations, and moves straight to the next active student workstation.



## TO MONITOR STUDENTS AUTOMATICALLY

1. To start students' automatic monitoring, click on a student icon. A monitor panel opens.

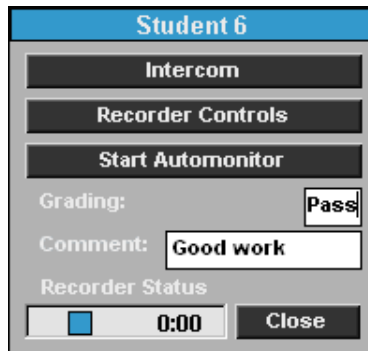

Monitoring panel

2. On the panel, click the **Start Automonitor** button.

On the Session Screen opens a replication of the monitored student's audio panel. The automatic monitoring starts.

To change the time interval for monitoring, edit the number of seconds in the monitoring time field.

The audio panel view changes as the monitored student changes. If you want to communicate to or with a student, click the **Intercom** button. In the intercom mode, the connection between you and the student opens so that the student hears your voice and is able to reply. Opening an intercom connection with some other student than the monitored one stops the automonitoring.

→ For more information about the intercom mode, see chapter *Intercom*.

3. To stop monitoring, click the **Stop Automonitor** button.

You can also open the Grading window at any point, by clicking on the **Grading** button.

→ For more information about grading students, see chapter *Grading students*.

4. To close the student's audio panel view, click the **Close** button.

## BOOKMARKS

Bookmarks are for marking passages in the audio material, so that you can easily return to the selected parts in the audio material without having to rewind or fast-forward to find the right passage. When you click a set bookmark, the track starts playing from the selected place onward.

Lab 100 contains ten bookmarks that either you or the students themselves can set to mark selected places in the

master or student track. The students can set bookmarks by pressing the bookmark keys on their audio panel. You mark the material for your students via your GUI.

### **SETTING BOOKMARKS FOR THE STUDENTS**

There are two ways to set bookmarks for the student.

Click on a student icon. In the monitoring panel that appears, click the **Recorder Controls** button. A view of the student's audio panel opens on the Session Screen. On the audio panel view, click on the bookmark keys of the student's audio panel to mark the selected passages.

-Or-

When your source is an MSU file, under the audio source field, click the **Controls...** button. A panel for the MSU controls opens. In the panel, click the number buttons to set bookmarks. To clear bookmarks, first click the **Clear** button, and then click the button of the bookmark you want to remove.

Clicking the **Free** button in the Session screen activates the bookmarks.

### **THE STUDENTS SET THE BOOKMARKS**

The students set bookmarks by pressing the bookmark keys on their audio panels.

→ For more information about setting bookmarks, see chapter *User Audio Panel*.

## **CALLS**

### **ALL CALL**



When you want to talk to the whole class, click the **All Call** button on the toolbar. Once the activity is initiated, the source is muted during the call and the students can hear your voice. The source is being recorded normally on the master track, if recordings are on.

### **SESSION CALL**

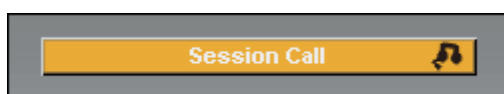

To talk to the students in a session, click the **Session Call** button on the Session Screen. For example, you can give the

students instructions before initiating an activity. Once the activity is initiated, the source is muted during the call and the students can hear your voice. The source is being recorded normally on the master track, if recordings are on.

## STUDENT CALL

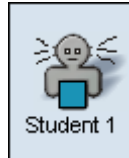

If you want to talk to a student briefly, call the student by pointing the student icon and pressing down the right mouse button. The student hears you as long as the right mouse button is pressed down, but is not able to reply. During the Student Call, both you and student are disconnected from the source.

## OUTSIDE CALL

Outside call allows you to talk to the self-access workstations, for example to inform them that the system will be rebooted. To call the self-access workstations, open the Lab 100 **Menu**, choose **Self-access setup** and in the dialog that opens click on the **Outside Call** button.

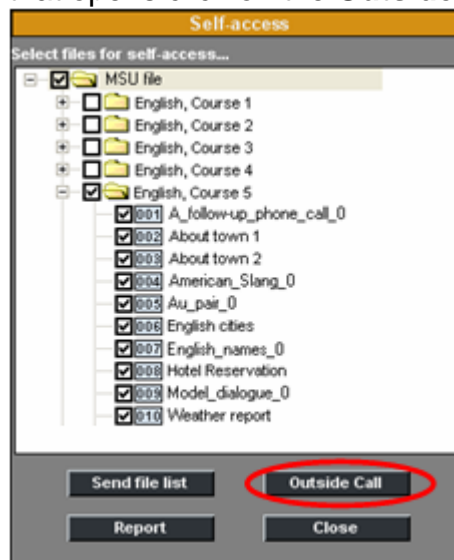

# ACTIVITY PROCEDURES

## GENERAL PROCEDURE

The following steps describe the general procedure of the Lab 100 activities, and guide you through the main Lab 100 session procedures.

By following these steps you can perform any of the Lab 100 activities. After the general description, each particular activity is explained in detail to guide you through the specific characteristics of each activity.

### **CREATING A SESSION**

1. In the toolbar, click the **New Session** button.



The Session Screen activates.

### **SELECTING MEMBERS FOR THE SESSION**

You can select members for the session, by either mouse clicking to select an individual, or by dragging the mouse over a number of student icons.

2. Click on a student icon, or drag the mouse over the student icons you want to include in a session.
3. If you want to change your selection, that is, add or remove students, click the **Add/Remove** button, and select again.

Note that you can make multiple consecutive selections, by pressing and holding down Shift or Ctrl on your keyboard, and selecting the students as described above.

### **SELECTING AN ACTIVITY FOR THE SESSION**

4. Select an activity from the list that opens by clicking on the activity field. The controls needed to accomplish the activity appear.

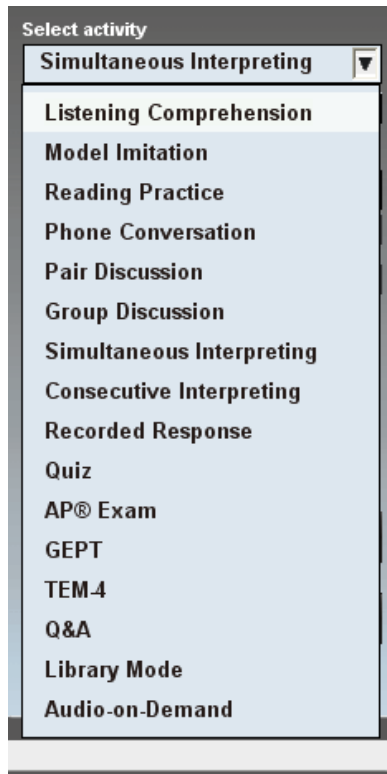

*The Lab 100 activity list*

### **SELECTING AN AUDIO SOURCE**

5. Select audio source from the list that opens by clicking the source field.



*A drop-down menu for the Lab 100 audio sources*

### **SESSION CONTROLS**

6. To give instructions, click the **Session Call** button.

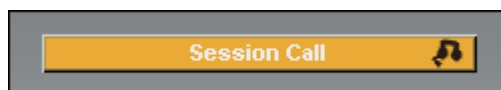

The red-highlighted *On the Air* sign appears in the upper right corner of the main window.



All the students in the session now hear your voice. To break the connection, click the button again.

7. To initiate the activity, click **Start**.



Initiating an activity means connecting the audio source to students and starting the recording(s).

If your source is an MSU file, the activity starts when you click the Start button. If the source is any other than an MSU file, remember to start also the source player. For example, to start to play a CD, click play in the CD player.

### ***PAUSING THE ACTIVITY***

You may want to pause the activity, for example, to ask students questions.

8. To pause the activity, click **Pause**.



Pausing the activity means pausing the recordings and the connection between the students and the source. Auxiliary sources are stopped manually.

9. To continue the activity, click **Continue**.



The students are connected to the source again. Auxiliary sources are started again manually.

10. To stop the activity, click **End**.



The source is disconnected from the students. Auxiliary sources are stopped manually.

### ***ALLOWING STUDENTS ACCESS TO THEIR RECORDERS***

You can now allow the students practice individually. To do this, click **Free** to set the students' audio panels to free mode.



The students are then able to work with the master track at their own pace. Note that if the material used for the activity is an MSU file, you can set the student audio panels to free mode right away, without listening to the source together first.

In Free mode, if the source the students are working with is other than an MSU file, the program prompts you to define the time the students are able to record their output.

→ For more information about allowing the students' individual work, see *Free and Lock mode*.

### **REPLAYING THE STUDENT TRACKS**

If you have recorded the student tracks during the activity, you can replay the tracks for the students. By doing this, you have more time to monitor the students and comment on their work.

To replay the student tracks, click **Replay**.



→ On how to monitor a student, see chapter *Monitor and intercom* earlier in this guide.

The playback stops automatically when the tracks reach the end. You yourself can stop the playback by clicking the button again. However, if you stop the playback and click the button again to restart the playback, the track is played from the beginning.

### **GRADING STUDENTS**

To open the grading window, click the **Grading** button.



For more information about grading students, see chapter *Grading students* later in this guide.

### **EXITING THE SESSION**

11. To quit the session, click the **Exit Session** button.



A panel for saving the master track or collecting the student tracks opens (see the description below).

# SAVING, PODCASTING AND COLLECTING THE TRACKS

Clicking the **End** or **Exit Session** button opens the following window for saving or podcasting the master track and collecting the student tracks.



Window for saving or podcasting the master track and collecting the student tracks

## SAVING THE MASTER TRACK

If you selected to record the master track during the activity (in the **Activity Options** panel), you can choose to save it also for later use. For example, if your source material for the activity was on CD audio, you can choose to digitize the master track to the Media Storage Unit, and use it from there the next time you want to play the exercise. The advantage of having the source as an MSU file is that you can let the students work with the source individually right away, without having to listen to it together, i.e. save it to the MSU first.

→ For more information about the MSU file, see chapter *MSU File* in the *Audio Connections* section of this guide.

To save the material, click **Save**. The program prompts you to browse for a location for saving and naming the file. When you have saved the material, to close the panel and exit the session, click **Close**.



## **PODCASTING THE AUDIO MATERIAL**

You can create a podcast out of the audio material on the master track. The podcast can then be distributed to students over the Internet.

To create a podcast of the master track, click on the **Podcast** button.



The image shows a dialog box titled "Lab 100 Podcast master track". It contains three input fields: "Title", "Description", and "Remote directory". The "Remote directory" field is a dropdown menu currently showing "English". At the bottom are "OK" and "Cancel" buttons.

In the dialog that opens, enter the following:

- **Title** – Enter a title for the podcast file. This will be displayed on the podcast Web page where the file can be downloaded.
- **Description** – Enter a description of the contents of the file. This will be displayed on the podcast Web page where the file can be downloaded.
- **Remote Directory** – Select the location where the podcast will be uploaded and made available to students

Once you have entered the information above, click **OK**. The podcast will now be uploaded to the selected location. When the uploading has finished, a dialog will appear displaying the Web address where the podcast is now available.

## **COLLECTING THE STUDENT TRACKS**

If you selected to record the student tracks during the activity, you can now choose to collect the student tracks for later evaluation.

1. To collect the student tracks, click **Collect**. The following window opens.

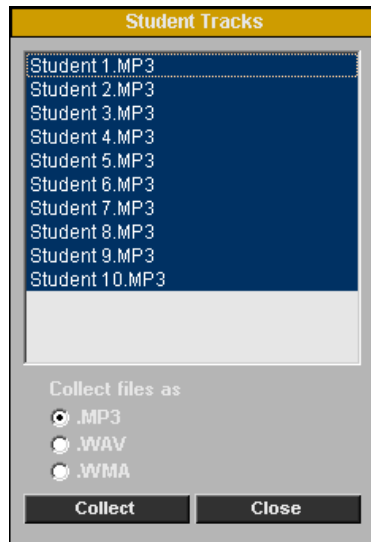

Window for saving the student tracks

In the window are displayed the recorded student files, that can be copied and saved to your computer or to any medium accessible from your computer.

You can choose whether you want to collect the files in mp3, wav or wma format. To change the file format, select the option accordingly.

2. In the window, click **Save**. A window for browsing for a folder opens. By default, all the files are selected (highlighted). To select only some of the student files, click on the display and select the files you want to save.
3. After you have selected a saving location for the files, the program starts the saving. A **Saving...** window appears, where you can view the file that is currently being saved.

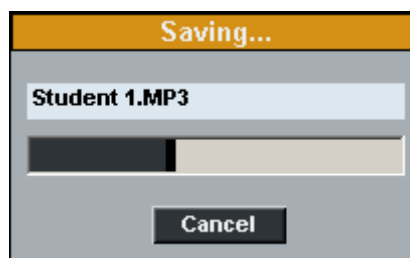

To cancel the saving, click **Cancel**.

4. After the saving is completed, click **Close** to exit the window.

## USING THE LAB 100 RECOVERY APPLICATION

The Lab 100 system includes an application for recovering lost student files. The recovery program enables you to save students' work even if there has been a failure during the collection or saving of the student tracks.

If the program was not shut down properly at the end of a previous session, and the collection or saving of student tracks was not completed successfully, the following message appears on your screen when you start the Lab 100 application.

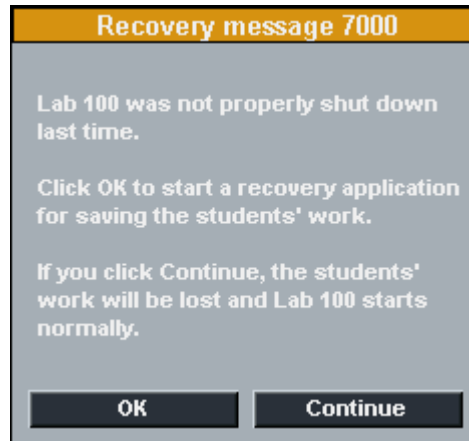

1. To start the recovery of student files, in the message dialog, click **OK**.

**Note** that if you click the Continue button, the students' work will be lost and the program starts normally.

2. Clicking OK opens the Lab 100 Recovery Application.

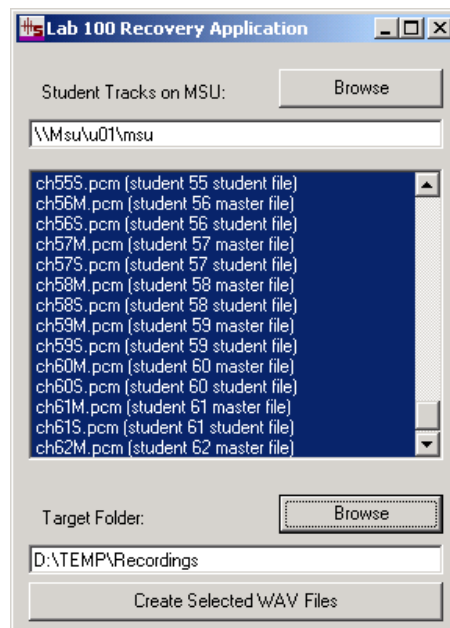

*The Lab 100 Recovery Application*

3. In the application window, under "Student Tracks on MSU", a list of raw data files is displayed.
4. If the appropriate files are not displayed in the window, you can browse for them by clicking **Browse** in the upper right corner in the dialog.

When you have found the files that you want to recover, select a saving location.

5. To browse for a saving location, next to the “Target Folder” text, click **Browse**.

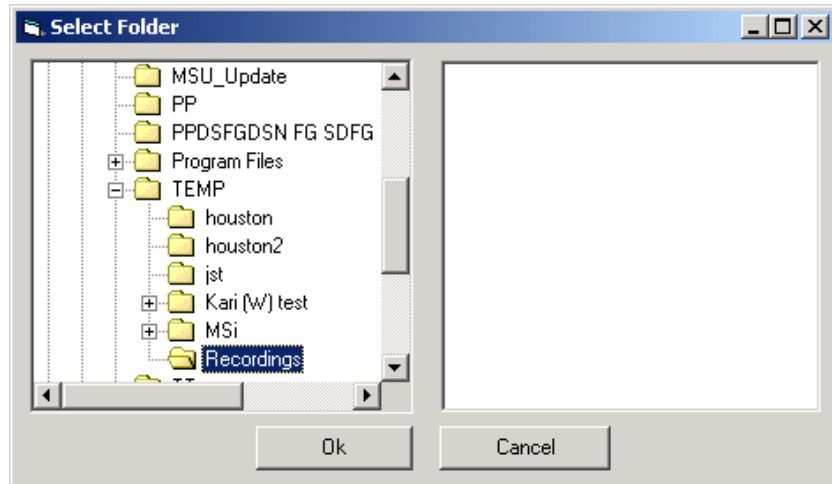

6. In the dialog that opens, browse for a saving location and click **OK**. The saving path appears in the “Target Folder” edit box.

When you have selected the saving location, you can start to create wav files of the selected student tracks.

7. To start the file recovery, click **Create Selected WAV Files**.
8. The file creation dialogs, that appear in the screen during the recovery, indicate that the program is in progress.

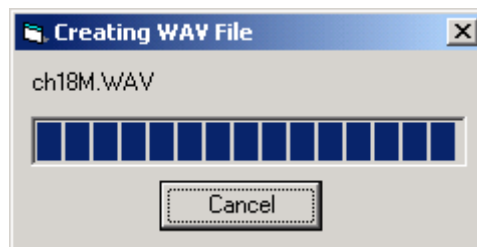

9. When the recovery is completed, close the Lab 100 Recovery Application window.

## GRADING STUDENTS

The Grading feature of SANAKO Lab 100 allows you to evaluate students by giving them grades from a chosen grade scale and by adding written comments. Student grades can easily be printed out and saved for later use.

You can open the grading window by clicking on the **Grading** button at the low left corner of the Session screen or the Recorder controls window.

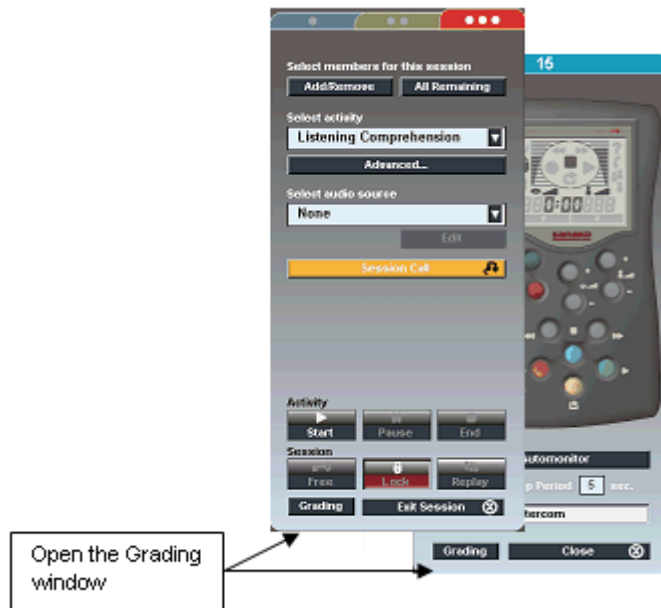

Students are displayed in the Grading window either in an alphabetical order or according to their student numbers. This can be chosen in the Lab 100 Properties window. To open the Properties window, go to the Lab 100 Main menu and select **Properties....**

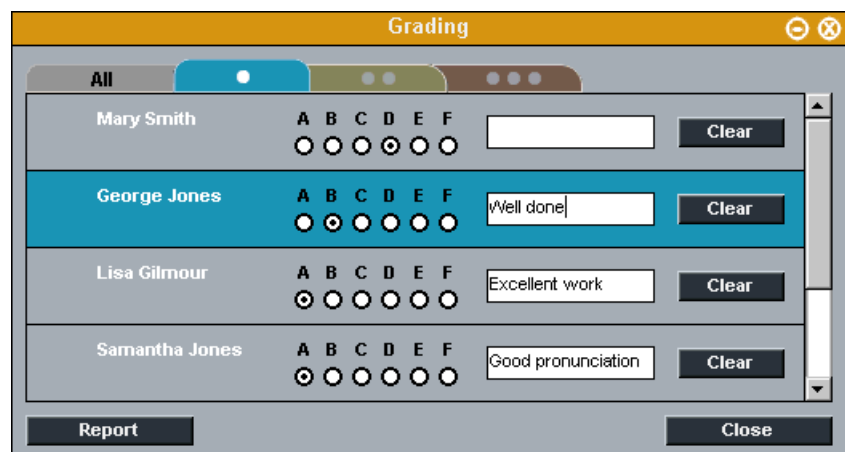

*The Grading window*

The Grading window contains a separate tab for each session, as well as an All tab for displaying all the students in the lesson. These are situated at the top of the view.

To grade a student, click on the desired grade button on the grade scale next to the student's name. The grade scale can be changed in Lab 100 Properties. The grading window also contains a field for additional notes and comments for each student. The grade and comments given to each student can be cleared by clicking on the student's **Clear** button.

Once you have graded a student, a check mark will appear next to the respective student's icon to indicate that s/he has been given a grade.

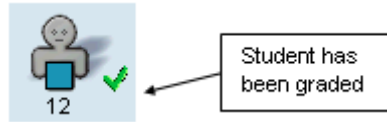

This allows you to see at a glance, which students have already or have not yet been given grades.

Clicking on the **Report** button opens a Grading Report window.



## GRADING REPORT

The grading report window provides you with an easy-to-view listing of all given grades. It displays the date and time of the report, each student's name and grade with comments if any, as well as lists of students without a grade or absent at the time of grading.

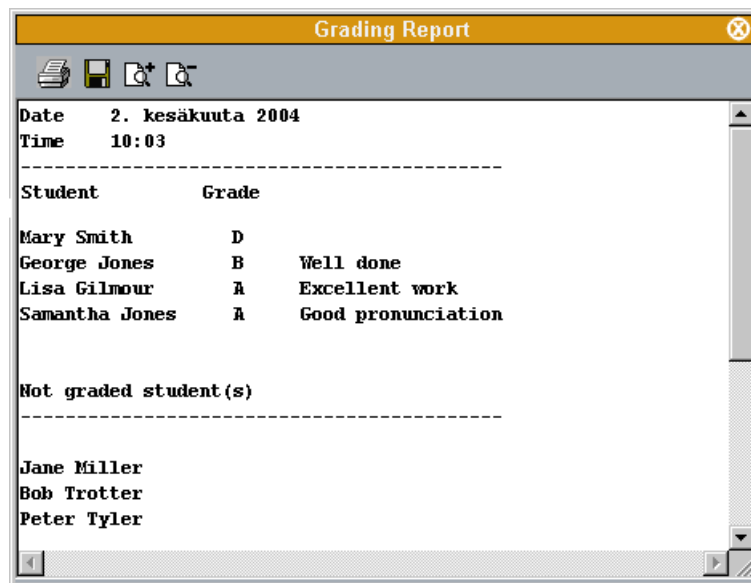

*Grading Report window*

By clicking the appropriate control buttons you are able to save the report on your computer or anywhere in the network and print it out. Additionally, you can zoom the window in or out to decrease or increase the font size, and scale the report to fit the sheet you want to print it on.

## PRINTING THE GRADING REPORTS



You can print the Grading report by clicking the printer symbol on the upper left corner of the report window. The report is printed to the Windows default printer.

In the Grading Report window, clicking the print command button opens a print settings dialog before starting to print. For example, you can change the destination printer if needed.

### ***SAVING THE REPORT***



By clicking the disk symbol on the upper left corner of the window, you can save the report to your computer or anywhere in the network.

### ***ZOOMING IN AND OUT THE REPORT VIEW***

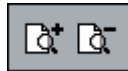

Note that the font size in the printed report is the same as the one seen on your screen. To zoom the font size in or out, click the symbols on the upper part of the report window. If you zoom the report in or out and print it out, the font size of the print is changed accordingly.

### ***ADJUSTING THE REPORT VIEW***

The print sheet scales automatically on your screen; to fit the whole report to the sheet you want to print on, you may want to enlarge the report window.

To change the size of the Grading Report window, click on a side or a corner of the window and, with the mouse button pressed down, drag the side or corner to adjust the window size as appropriate.

### ***CLOSING THE REPORT WINDOW***



To close the report window, click on the symbol in the upper right corner of the window.

### ***REPORT WINDOW TOOLTIPS***

In the Grading Report window, when you move the mouse pointer over a control button, a tooltip text appears explaining what each button on the toolbar does.

## **SELECTING A STUDENT TO ANSWER A QUESTION**

While proceeding with a Lab 100 activity, you may want to ask the students questions to review the right answers for the exercises.

For example, the students can indicate they want to answer a question by pressing the Call Teacher key on their audio panel. The calling student's icon tells you that he or she wants to answer, and you can give him or her the answering turn by performing the following steps:

1. Click **Pause**. Remember to pause any auxiliary sources manually.
2. To talk to the students in the session, click the **Session Call** button.

When you now move the mouse pointer to the class view, you can see that instead of the usual arrow, the mouse pointer is now a speech bubble indicating that the answering mode is on.

3. Click the student you want to answer the question.

A speech bubble appears on the answering student's icon. Everybody in the session, including you, hears the answer. To select another student, just click on the icon of that student. To mute the answering student, click anywhere on the class view.

## FREE AND LOCK MODE



The Free and locked mode mean the control the students have to the material they are working with via their audio panels.

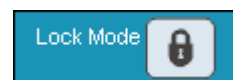

In the Lock mode the students are able to

- call the teacher
- adjust the volume
- set bookmarks

but they are not able to use the recorder controls or clear, search for or repeat bookmarks.



When you free the student audio panels, the students are able to work with the given material individually. This means that they can listen to the master track indefinitely, and record on a student track.



Note that students are never able to modify the master track; all the changes (recordings) are made on the student track.

The default mode is different for each activity. In the AP® Exam, the students' recorder controls remain locked throughout the whole session and therefore, in the AP® Exam, no free command is available.

If your audio source resides in the Media Storage Unit (**MSU File**), you can send the source to your students, and allow them to work with it individually right away, without listening to the exercise together first.

In Free mode, if the source the students are working with is other than an MSU file, the program prompts you to define the time the students are able to record their output.

If the **Extra recording time in Free mode** option has been enabled in the Lab 100 **Properties** window, the students will be able to continue to record themselves after the program track has ended. When you click on the **Free** button, Lab 100 will prompt you to define the time, in minutes, that students are allowed to record after the end of the source track.

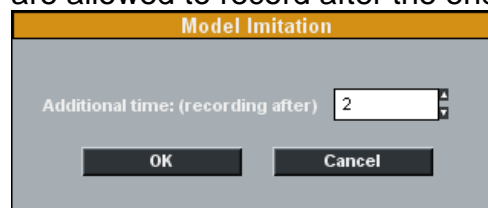

→ To learn how to create an MSU file, see chapter *Creating an MSU file*.

# LISTENING COMPREHENSION

In the Listening Comprehension, the students listen to a source, and you can ask questions on the heard material to check for understanding. After you have listened to the source together, you can free the students to work with the source individually. In other words, the students can set bookmarks to find passages or tracks easily again, and control the source at own pace.

## **DEFAULT RECORDING SETTINGS**

|                      |                                     |
|----------------------|-------------------------------------|
| Record master track  | <input checked="" type="checkbox"/> |
| Record student track | <input type="checkbox"/>            |

## **PROCEEDING WITH LISTENING COMPREHENSION**

1. To give instructions, click **Session Call**. To end the call, click the button again.
2. To initiate the activity, click **Start**. The source is connected to the students and the recording start.

If your source is an MSU file, the activity starts when you click the Start button. If the source is any other than an MSU file, remember to start also the source player. For example, to start to play a CD, click play in the CD player.

## **PAUSING THE SOURCE**

If you want to give the students time to answer questions, pause the audio source.

If your source is an MSU file, click pause in the MSU controls. All the other source players you will pause by pressing or clicking pause in the player.

## **PAUSING THE ACTIVITY**

However, if you want to look for a certain passage or track on the source without the students hearing it or without having that recorded, pause the activity. Pausing the activity disconnects the students from the source and stops recording, and you can rewind and forward wind the source as much as needed.

3. To pause the activity, click **Pause**. The connection between the students and the source mutes, and the recording pauses.

If your source is an MSU file, clicking the Pause button pauses also the MSU player. If your source is other than an MSU file, remember to pause the source player also.

## **ASKING QUESTIONS**

You can now ask students questions on the heard material.

4. To talk to the students, click the **Session Call** button. All the students in the session now hear your voice. To mute the connection, click the button again.

## **SELECTING A STUDENT TO ANSWER A QUESTION**

Some students indicate they want to answer the question.

5. To select the student you want to answer the question, do as follows:
  - Click the **Session Call** button to communicate to the students in the session. During the call, the audio source is muted and the students can hear your voice. If recording is on, your voice is recorded to the master track.
  - Click the student you want to answer the question.

A speech bubble appears on the answering student's icon. Everybody in the session, including you, hear/s the answer. To mute the answering student, click anywhere on the class view.

## **CONTINUING THE ACTIVITY**

6. To go on with the activity, click **Continue**. The source is connected to the students again and the recording go on.

If your source is an MSU file, the source file continues to play. If your source is any other than an MSU file, start the source player again.

Alternatively, you can continue asking questions. For asking questions, repeat steps 3 and 4.

## **ENDING THE ACTIVITY**

7. To end the activity, click **End**. The connection between the students and the source mutes, and the recording stops.

If your source is an MSU file, ending the activity also stops the source. If your source is other than an MSU file, stop the source in the device or player.

If any tracks were selected to be recorded during the activity (selection made in the Activity options window that opens by clicking the **Advanced...** button), clicking the **Exit Session** button opens a window for saving the master track or collecting the student tracks appears.

### ***EXITING THE SESSION***

8. To quit the session, click the **Exit Session** button. A window for saving the source material opens.

### ***SAVING THE SOURCE MATERIAL***

In Listening Comprehension, the program defaults for recording the master track during the activity. This means that at the end of the activity, exiting the session opens a window where you can choose to save the recorded material for later use.

→ For more information about saving the source material, see the chapter *Saving, podcasting and collecting the tracks*.

## MODEL IMITATION

The Model Imitation activity is an efficient way to practice the pronunciation and rhythm of a foreign language. In the Model Imitation activity, the student listens to a source and repeats after. You can use sources that are paused in proper gaps, or you can pause the source yourself during the activity. At the end of the activity, you can free the students to practice individually.

If your source is an MSU file that already has proper gaps for the student output, you can let the students work individually right away, without having to listen to the source together first.

### ***DEFAULT RECORDING SETTINGS***

|                      |                                     |
|----------------------|-------------------------------------|
| Record master track  | <input checked="" type="checkbox"/> |
| Record student track | <input checked="" type="checkbox"/> |

### **PROCEEDING WITH MODEL IMITATION**

1. To give instructions, click **Session Call**. To end the call, click the button again.
2. To initiate the activity, click **Start**. The source is connected to the students and the recording starts.

If your source is an MSU file, the activity starts when you click the Start button. If the source is any other than an MSU file, remember to start also the source player. For example, to start to play a CD, click play in the CD player.

### ***PAUSING THE ACTIVITY***

Note that pausing the activity means not only disconnecting students from the source but also pausing the recordings.

3. To pause the activity, click **Pause**. The connection between the students and the source mutes, and the recordings pause.

If your source is an MSU file, clicking the Pause button pauses also the MSU player. If your source is other than an MSU file, remember to pause also the source device or player.

### ***PAUSING THE SOURCE***

However, if you want to leave the students time to repeat after the source without pausing the recordings, you can pause only the source while the students are performing the activity.

If your source is an MSU file, click the **Controls...** button. In the control panel that opens, click pause.

If your source is other than an MSU file, pause the source player by clicking or pressing pause in the player.

### **CONTINUING THE ACTIVITY**

4. Click **Continue**. The students hear the source again and the recording continues.

If your source is an MSU file, the source file continues to play. If your source is any other than an MSU file, start the source player again.

### **STOPPING THE ACTIVITY**

5. To stop the activity, click **End**. The connection between the students and the source mutes, and the recordings stop.

If your source is an MSU file, ending the activity also stops the source. If your source is other than an MSU file, stop the source in the player.

If any tracks were selected to be recorded during the activity (selection made in the Activity options window that opens by clicking the **Advanced...** button), a window for saving the master track or collecting the student tracks appears.

### **SAVING THE SOURCE MATERIAL**

In Model Imitation, the program defaults for recording both the master and student tracks during the activity. This means that at the end of the activity a window opens where you can choose to save the recorded material for later use and to collect the student tracks for evaluation.

→ For more information about saving the source material and collecting the student tracks, see *Saving, podcasting and collecting the tracks*.

### **ALLOWING STUDENT'S ACCESS TO THEIR AUDIO PANELS**

You can now let the students work individually with their tracks.

6. To give instructions, click **Session Call**. To enable the recorder controls on student's audio panels, click **Free**.

→ For more information about allowing the students' individual work, see *Free and Lock mode*.

While your students are working individually, you may find useful to monitor your students. You can select students in random order, or start automonitoring, which means that you monitor all the present workstations one by one.

### **MONITORING STUDENTS**

→ For more information about the monitoring features, see *Monitor and intercom* and *Automonitor*.

### **EXITING THE SESSION**

7. To quit the session, click **Exit Session**.

# READING PRACTICE

Reading aloud is a useful way of practicing intonation, rhythm and pronunciation. This exercise is ideal for students' individual practice; students read a text onto the student track, and then practice individually and at their own pace to improve the output.

## ***DEFAULT RECORDING SETTINGS***

|                      |                                     |
|----------------------|-------------------------------------|
| Record master track  | <input type="checkbox"/>            |
| Record student track | <input checked="" type="checkbox"/> |

## **PROCEEDING WITH READING PRACTICE**

Proceeding with a reading practice is very simple. If you don't want to use any audio source in this activity, all you have to do is to allow students access to their audio panels.

1. To give the students instructions, click **Session Call**.

## ***PLAYING A MODEL SOURCE***

If you want to play the students a source track or file before starting the actual reading practice, proceed as in Listening Comprehension. If the Record master track box is checked in Default recording settings, you have the possibility to save the source material you have played for the students. When you click the End button to disconnect the source from the students, the program prompts for saving the source track or file.

However, if you want to let the students practice individually right away, you can let them record their output by using the controls on their audio panels. To unlock the recording control on the audio panel, do as follows.

## ***ALLOWING STUDENT'S ACCESS TO THEIR AUDIO PANELS***

2. To unlock the recording control on student audio panels, click **Free**. The students are now able to record their output.

## ***MONITORING STUDENTS***

While your students are working individually, you can observe their progress. You can choose to monitor students in random order, or you can start the automonitoring feature, which means that you monitor all the present session students one by one.

3. To monitor a student, click on a student icon. A monitoring panel appears.



- For more information about the monitoring features, see *Monitor and intercom* and *Automonitor*.
4. To quit the session, click **Exit Session**.

# PHONE CONVERSATION

Talking on the phone is known to be one of the most difficult tasks in a foreign language. This is why an activity such as Phone Conversation can be an efficient form of language instruction.

In Lab 100 phone conversation, students call each other through their audio panels.

## **DEFAULT RECORDING SETTINGS**

|                      |                          |
|----------------------|--------------------------|
| Record master track  | <input type="checkbox"/> |
| Record student track | <input type="checkbox"/> |

## **PROCEEDING WITH PHONE CONVERSATION**

### **MAKING CALLS**

Students dial the number of a fellow student by pressing the number keys on their audio panel. The line opens between the students, and the phone conversation can begin.

In Phone Conversation, students can see the other pair member's workstation number on the their audio panel's display.

1. To initiate the activity, click **Start**. A phone symbol is lit on the audio panel's display to indicate that the students are free to dial.



*User Audio Panel's display*

### **DIALING A NUMBER**

Students dial the number of a selected student's workstation. The workstation numbers consist of two digits meaning that if the number is smaller than 10, a leading zero must be dialed before the actual number, e.g. 09. The number appears on the display.

If the connection is established successfully, the pair discussion symbol (two student symbols highlighted) is lit on the audio panel's display, and the source is connected to students.

## **RECORDING THE CONVERSATION**

If recording student track recording has been selected in the Advanced settings in the Session screen, the recording of the phone conversation starts automatically when an audio connection is established between the students.

## **DIALED WORKSTATION NOT AVAILABLE**

If the line is busy, the dialed workstation doesn't belong to the dialing student's session or doesn't exist at all, incorrect answer's symbol is lit on the display.

To hang up the phone, students press the clear key on their audio panel.

## **MONITORING STUDENTS**

While your students are working in pairs, you can observe their progress and make comments, if appropriate. You can choose to monitor students in random order, or you can start the automonitoring feature, which means that you all the present session students one by one.

2. To monitor a student, click on a student icon. A monitoring panel appears.

→ For more information about the monitoring features, see *Monitor and intercom* and *Automonitor*.

## **GIVING INSTRUCTIONS WITHOUT BREAKING THE CONNECTION**

There are three options for communicating with students during the activity without disconnecting them from each other:

To talk to all the students in the lesson, click **Session Call**. For example, if you want to tell the students to change pairs, call the session to give instructions and the students can then dial a new number on their audio panels.

To talk to a single student, right-click a student icon and select **Student Call**.

To have a private discussion with a single student, right-click a student icon and select **Private Conversation**.

## **ENDING THE ACTIVITY**

3. To stop the activity, click **End**. Ending the activity breaks the connection between the students, and they can no longer call each other. All symbols disappear on the audio panel's display.
4. To quit the session, click **Exit Session**.

# PAIR DISCUSSION

The Pair Discussion activity enhances students' communicative skills, since the student has to make him/herself comprehensible to the discussion partner. In pair discussion, the students can repeat the message to check for understanding, and express themselves by using their own words instead of fixed structures.

You can choose from different pairing methods. In addition, once you have initiated the activity for a session, you can monitor or join the pair's work at any point.

→ For more information about monitoring a pair or opening an intercom connection, see chapter *Monitor and intercom* earlier in this guide.

## DEFAULT RECORDING SETTINGS

|                      |                          |
|----------------------|--------------------------|
| Record master track  | <input type="checkbox"/> |
| Record student track | <input type="checkbox"/> |

## PROCEEDING WITH PAIR DISCUSSION

### PAIRING METHOD

By default, the selecting of the Pair Discussion activity forms pairs automatically so that the adjacent sitting students form a pair. If you don't want to change the pairing method, you can initiate the activity right away, without having to pair the students. However, if you want the program to form pairs in random order or you yourself want to pair the students manually, select the pairing method accordingly.

|                       |                      |
|-----------------------|----------------------|
| Select pairing method |                      |
| <b>Fixed</b>          | Adjacent students    |
| <b>Random</b>         | Randomized pairs     |
| <b>Manual</b>         | Selection by teacher |

Panel for selecting the pairing method

The three different ways of pairing the students:

### **FIXED**

The default option of the program. Selecting the Pair Discussion activity pairs the adjacent students automatically.

### **RANDOM**

The program establishes pairs in random order. Select the option accordingly.

## MANUAL

You will establish the pairs manually. To pair the students, select the option accordingly.

Next click on a student icon. A pink-highlighted *Pairing...* sign appears under the student's icon. Click on another student's icon. The students now form a pair. Under each student icon appears the pair member's name or workstation number highlighted in pink.

### WHAT IF A STUDENT IS LEFT WITHOUT A PAIR?

If a student was left without a pair, he/she is automatically added as a third member to an already existing pair.

You can also pair the extra student with yourself, by right-clicking the student icon and selecting **Pair with teacher**.

### INITIATING AND MONITORING A PAIR DISCUSSION

1. To initiate the activity, click **Start**. The connection opens between the students and the source (if selected) is connected to the students.

In Pair Discussion, students can see the other pair member's workstation number on their audio panel's display. The pair member's number can be seen on the display during the activity when no recordings are being made. In free mode, however, no pair numbers are displayed.

While your students are working in pairs, you can observe their progress and make comments, if appropriate. You can choose to monitor students in random order, or you can start the automonitoring feature, which means that you monitor all the present session students one by one.

2. To monitor a student, click on a student icon. A monitoring panel appears.

→ For more information about the monitoring features, see *Monitor and intercom* and *Automonitor*.

### GIVING INSTRUCTIONS WITHOUT BREAKING THE CONNECTION

There are three options for communicating with students during the activity without disconnecting them from each other:

To talk to all the students in the lesson, click **Session Call**.

To talk to a single student, right-click a student icon and select **Student Call**.

To have a private discussion with a single student, right-click a student icon and select **Private Conversation**.

## **CHANGING PAIRINGS**

You can set up new pairs when the activity is paused or ended.

3. To pause or end the activity, click **Pause** or **End**.

If your source is an MSU file, clicking the Pause or End button pauses or stops also the MSU player. If your source is other than an MSU file, remember to pause or stop also the source player.

4. If you want to pair the students again, select a pairing method (click the button accordingly). If you pair the students again manually, after clicking the **Manual** button, click on the icons of the students you want to form a pair.
5. To start the activity for the new pairs, click **Continue** or **Start**, depending on whether the activity was paused or ended.
6. To quit the session, click **Exit Session**.

# GROUP DISCUSSION

In a group discussion activity, students develop their communicative skills and learn to react appropriately, for instance, in situations where intercultural communication is involved.

You can define the number of members in a group, and you can monitor and join the group's work at any point of the exercise.

## **DEFAULT RECORDING SETTINGS**

|                      |                          |
|----------------------|--------------------------|
| Record master track  | <input type="checkbox"/> |
| Record student track | <input type="checkbox"/> |

## **PROCEEDING WITH GROUP DISCUSSION**

### **GROUPING METHOD**

By default, the selecting of the Group Discussion activity forms groups automatically so that the adjacent sitting students form a group. If you don't want to change the grouping method, you can initiate the activity right away, without having to group the students first.

However, if you want the program to form groups in random order or you yourself want to group the students manually, select the grouping method accordingly.

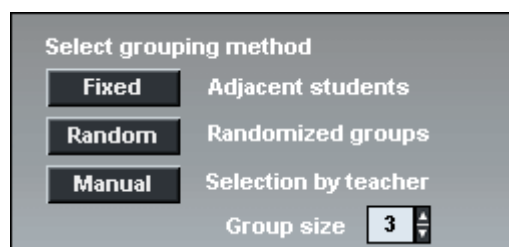

The panel is titled "Select grouping method" and contains three rows of buttons. The first row has "Fixed" and "Adjacent students". The second row has "Random" and "Randomized groups". The third row has "Manual" and "Selection by teacher". Below these buttons is a "Group size" label followed by a numeric input field containing the number "3" and a small up/down arrow icon.

*Panel for selecting the grouping method*

Before selecting the grouping method, you can define the number of members you want to include in a group by entering the desired number in the **Group Size** field. The minimum number of members in a group is 2, and the maximum the number of students in the session. By default, the size of a discussion group is the number of students in the session. There are three different ways to group the students:

### **FIXED**

The default option of the program; the adjacent sitting students form a group. Selecting the Group Discussion activity groups the students automatically. Under the

students' names appears the name of the group they belong to (for example, *Group 1*, *Group 2* etc.) When you move the mouse pointer over a group, the names of the pointed group members turn to pink. If you want to change the number of students in a group, edit the number field.

### ***RANDOM***

This program groups the students in random order. Under the students' names appear the name of the group they belong to (for example, *Group 1*, *Group 2* etc.) When you move the mouse pointer over a group, the names of the pointed group members turn to pink.

### ***MANUAL***

You will form the groups manually. Click on the student icons that you want to include in a group. When you click on the student icon, under the icon appears a red-highlighted *Grouping...* text. If you have defined the group to include three students (see the **Group Size** field), click on three student icons. Clicking the last student forms the group. Under the group members' icons appears the group's name (for example *Group 1*, *Group 2*, etc.).

### ***WHAT IF THE NUMBER OF STUDENTS DOESN'T MATCH?***

If one student was left over from the grouping, he or she is included as an additional member in one of the groups. If two or more students were left over, the remaining students form a group with each other.

You can also pair yourself with an extra student by right-clicking the student icon and selecting **Pair with teacher**.

### ***INITIATING AND MONITORING A GROUP DISCUSSION***

1. To initiate the activity, click **Start**. The connection opens between the students.
2. To listen to a group's discussion, click on the icon of one of the group members.  
→ For more information about monitoring a student, see chapter *Monitor and intercom* earlier in this guide.
3. If you want to join the group's discussion, click on the icon of one of the group members. A panel for monitoring the student(s) opens.
4. In the panel, click **Intercom**. The students now hear your voice. In Intercom, if recordings are on, your voice is mixed to the source and recorded to the student track.



### ***GIVING INSTRUCTIONS WITHOUT BREAKING THE CONNECTION***

There are three options for communicating with students during the activity without disconnecting them from each other:

To talk to all the students in the lesson, click **Session Call**.

To talk to a single student, right-click a student icon and select **Student Call**.

To have a private discussion with a single student, right-click a student icon and select **Private Conversation**.

### ***GROUPING THE STUDENTS AGAIN***

You can set up new groups when the activity is paused or ended.

5. To pause or end the activity, click **Pause** or **End**.

If your source is an MSU file, clicking the Pause or End button pauses or stops also the MSU player. If your source is other than an MSU file, remember to pause or stop also the source player.

6. If you want to group the students again, select a grouping method (click the button accordingly). If you group the students again manually, after clicking the **Manual** button, click on the icons of the students you want to form a group.

7. To start the activity for the new groups, click **Continue** or **Start**, depending on whether the activity was paused or ended.

8. To quit the session, click **Exit Session**.

# SIMULTANEOUS INTERPRETING

In Simultaneous Interpreting, the source is interpreted simultaneously into another language. Interpreting from one language to another requires an advanced competence in the foreign language.

## **DEFAULT RECORDING SETTINGS**

|                      |                                     |
|----------------------|-------------------------------------|
| Record master track  | <input checked="" type="checkbox"/> |
| Record student track | <input checked="" type="checkbox"/> |

## **PROCEEDING WITH SIMULTANEOUS INTERPRETING**

### ***WHEN THE AUDIO SOURCE IS AN MSU FILE***

If your audio source is an MSU file, you can let the students work with the source individually right away, without having to listen to the source together first (i.e. starting the activity).

If you want to give your students instructions before they start to interpret, click **Session Call**.

### ***WHEN THE AUDIO SOURCE IS OTHER THAN AN MSU FILE***

If your source is other than an MSU file, you will first play the source material once in order to initiate the activity to connect the source to the students and to start recordings. After that you can free the students to listen to and re-record their output again.

1. To initiate the activity, click **Start**. The source is connected to the students and the recording start.

If your source is an MSU file, the activity starts when you click the Start button. If the source is any other than an MSU file, remember to start also the source player. For example, to start to play a CD, click play in the CD player. The students don't hear themselves as they interpret the source (Sidetone OFF).

Note that pausing the activity pauses also the recordings.

2. To end the activity, click **End**. A window for saving the master track or collecting the student tracks opens.

If your source is an MSU file, clicking the End button stops also the MSU player. If your source is other than an MSU file, remember to stop the source player also.

## **SAVING THE SOURCE MATERIAL**

In Simultaneous Interpreting, the program defaults for recording both the master and student tracks during the activity. This means that at the end of the activity, a window opens where you can choose to save the recorded material for later use and collect the student tracks for evaluation.

→ For more information about saving the source material and collecting the student tracks, see *Saving, podcasting and collecting the tracks*.

## **ALLOWING STUDENT'S ACCESS TO THEIR RECORDERS**

3. To free the students to practice individually, click **Free**. The students are now able to work with their track individually.

## **MONITORING STUDENTS**

While your students are working individually, you can listen to them by using the monitoring feature.

4. To monitor a student, click on a student icon. A monitoring panel appears.

→ On how to monitor a student, see chapter *Monitor and intercom* earlier in this guide.

5. To quit the session, click **Exit Session**.

# CONSECUTIVE INTERPRETING

Consecutive interpreting means that the source is interpreted into another language in sections. The speaker stops at the end of every 'paragraph', and the interpreter then interprets what was said. By default, both the master and student track is recorded.

As a source, you can use an MSU file that has proper gaps for the student output. When using an MSU file, pausing the activity also pauses the recordings. Using controls, an MSU file can be paused without pausing the recording.

When using an external source, you can pause the external source manually without pausing the recording.

## ***DEFAULT RECORDING SETTINGS***

|                      |                                     |
|----------------------|-------------------------------------|
| Record master track  | <input checked="" type="checkbox"/> |
| Record student track | <input checked="" type="checkbox"/> |

## **PROCEEDING WITH CONSECUTIVE INTERPRETING**

### ***WHEN THE AUDIO SOURCE IS AN MSU FILE***

If your audio source is an MSU file, you can let the students work with the source individually right away, without having to listen to the source together first (i.e. starting the activity).

If you want to give your students instructions before they start to interpret, click **Session Call**.

### ***WHEN THE AUDIO SOURCE IS OTHER THAN AN MSU FILE***

If your source is other than an MSU file, you will first play the source material once in order to initiate the activity, to connect the source to the students and to start recordings. After that you can free the students to listen to and re-record their output again.

1. To initiate the activity, click **Start**. The source is connected to the students and the recording start.

If your source is an MSU file, the activity starts when you click the Start button. If the source is any other than an MSU file, remember to start also the source player. For example, to start to play a CD, click play in the CD player.

Note that pausing the activity pauses also the recordings.

2. To end the activity, click **End**. A window for saving the master track or collecting the student tracks opens.

If your source is an MSU file, clicking the End button stops also the MSU player. If your source is other than an MSU file, remember to stop the source player also.

### ***SAVING THE SOURCE MATERIAL***

In Model Imitation, the program defaults for recording both the master and student tracks during the activity. This means that at the end of the activity opens a window where you can choose to save the recorded material for later use and to collect the student tracks for evaluation.

→ For more information about saving the source material and collecting the student tracks, see *Saving, podcasting and collecting the tracks*.

### ***ALLOWING STUDENT'S ACCESS TO THEIR RECORDERS***

3. To free the students practice individually, click **Free**. The students are now able to work with their track individually.

### ***MONITORING STUDENTS***

While your students are working individually, you can listen to them by using the monitoring feature.

4. To monitor a student, click on a student icon. A monitoring panel appears.

→ On how to monitor a student, see chapter *Monitor and intercom* earlier in this guide.

5. To quit the session, click **Exit Session**.

## RECORDED RESPONSE

The Recorded Response activity is ideal for practicing intercultural communication through situational exercises. For example, students simulate a job interview with a prerecorded source and focus on reacting appropriately. When the exercise is completed, you may save and collect all of the oral test responses as individual files for later evaluation.

### **DEFAULT RECORDING SETTINGS**

|                      |                                     |
|----------------------|-------------------------------------|
| Record master track  | <input type="checkbox"/>            |
| Record student track | <input checked="" type="checkbox"/> |

### **PROCEEDING WITH RECORDED RESPONSE**

1. To initiate the activity, click **Start**. The students hear a question or a comment they should respond to. The student recording starts, and each student's response is recorded to a student track.

If your source is an MSU file, the activity starts when you click the Start button. If the source is any other than an MSU file, remember to start also the source player. For example, to start to play a CD, click play in the CD player.

If your source already has proper gaps for the student output, you can let the activity go on without clicking any buttons.

Note that in this activity, both the program and student output are recorded to the student track.

If the source doesn't have proper gaps, pause the source using the controls in the source device. The controls for an MSU file are on the Session Screen.

2. To end the activity, click **End**.

If your source is an MSU file, clicking the End button stops also the MSU player. If your source is other than an MSU file, remember to stop the source player also.

### **SAVING THE SOURCE MATERIAL**

In Recorded Response, the program defaults for recording both the master and student tracks during the activity. This means that at the end of the activity, a window opens where you can choose to save the recorded material for later use and to collect the student tracks for evaluation.

→ For more information about saving the source material and collecting the student tracks, see *Saving, podcasting and collecting the tracks*.

## **REPLAYING THE STUDENT TRACKS**

If you have recorded the student tracks during the activity (as set by default), you can replay the tracks for the students. By doing this, you have more time to monitor the students and comment on their work.

To replay the student tracks, click **Replay**.



→ On how to monitor a student, see chapter *Monitor and intercom* earlier in this guide.

The playback stops automatically when the tracks reach the end. You yourself can stop the playback by clicking the button again. However, if you stop the playback and click the button again to restart the playback, the track is played from the beginning.

3. To quit the session, click **Exit Session**.

# QUIZ

The Lab 100 Quiz is a quick and easy way to see how well the students answer the questions you ask. Just select the answer type, play a question, and start the answering time. Students' answers appear on your screen and you can immediately let the students know whether they answered correctly or not with the **True** and **False** keys on your GUI.

You can also save your quiz settings as a ready-to-use quiz file. This way there is no need to manually reselect the settings every time you use the Quiz activity.

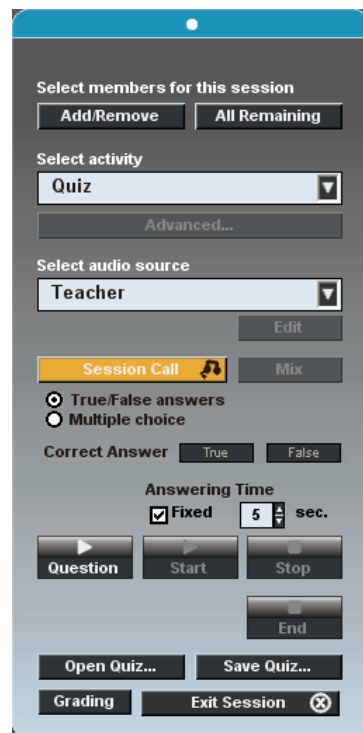

## DEFAULT RECORDING SETTINGS

|                      |                          |
|----------------------|--------------------------|
| Record master track  | <input type="checkbox"/> |
| Record student track | <input type="checkbox"/> |

## PROCEEDING WITH QUIZ

### SELECTING THE ANSWERING MODE

1. Before starting the quiz, select the answering mode according to the quiz type.

|   |
|---|
| <input checked="" type="radio"/> True/False answers |
| <input type="radio"/> Multiple choice               |

- Select the **True/False Answers** option, if the questions should be answered *True* or *False*.



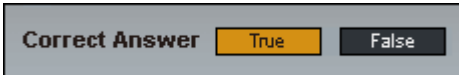

- Select the **Multiple choice** option, if the answers should be in numeric mode. After selecting the option, define the number of the answer choices (max. 8) by entering the number in the field accordingly. For example, entering the number 5 means that for each question there are five answer options.

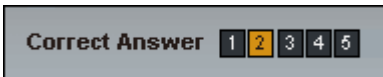

## STARTING THE QUIZ

2. To initiate the activity, click **Question**. The source is connected to students and you can now ask or play the first question.

If your source is an MSU file, the activity starts when you click the Question button. If the source is any other than an MSU file, remember to start also the source player. For example, to start to play a CD, click play in the CD player.

Clicking the **Question** button also opens a Quiz Graph that indicates the distribution of student answers.

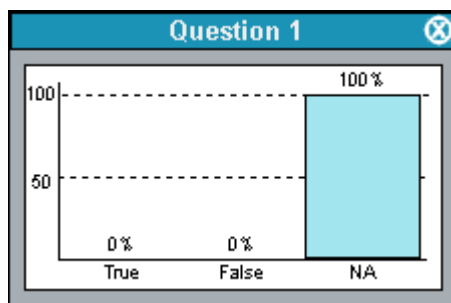

*The graph as no answers are given yet*

At this stage of the Quiz, the students have not yet given their answers, so the only block seen in the diagram is that of **NA**, "No Answers".

3. To let students answer the question, click **Start**.

If your source is an MSU file, the source pauses. If your source is any other than an MSU file, remember to pause the source device or player manually.

On the User Audio Panel, the LED indicators of the possible answer options start to blink. Students answer the question by pressing an answer key on their audio panel. The pressed key switches on and the other key(s) remain blinking.

In the diagram, the blocks stack as the students give their answers.

On the class view on your GUI is displayed a block diagram on the distribution of the students' answers.

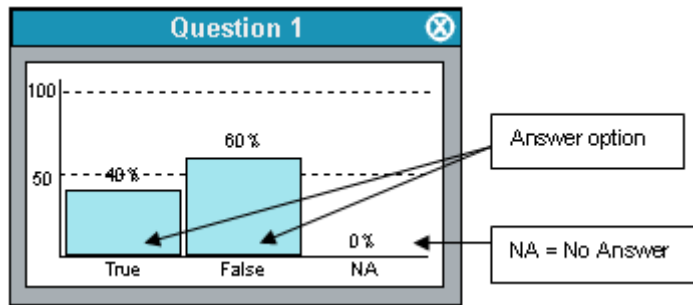

Each student's answer appears also under his or her icon.

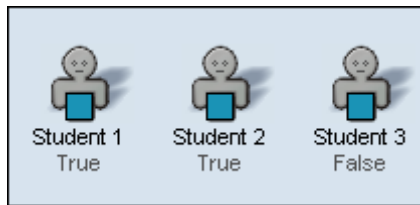

4. To end the answering time, click **Stop**. The answer keys on the students' audio panels are disabled, and the LED indicators next to the keys switch off.

You can now either repeat the steps 2, 3, and 4 to ask/play the next question or you can give the right answer. To give the right answer, do as follows.

### **GIVING THE CORRECT ANSWER**

5. Click on the correct answer's button. A symbol (correct or incorrect) on the students' audio panel's display tells the students whether they answered the question correctly or not.

In the diagram, the block of the correct answer is highlighted in orange.

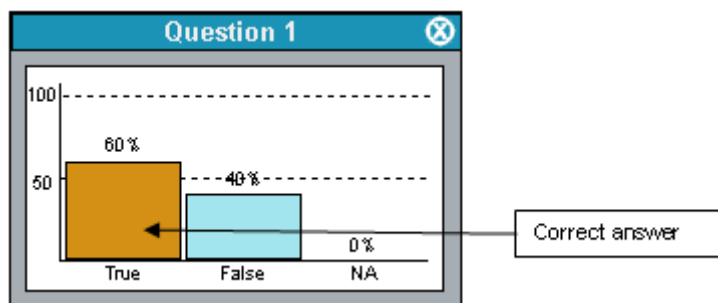

On the class view, the correct answers are highlighted in pink.

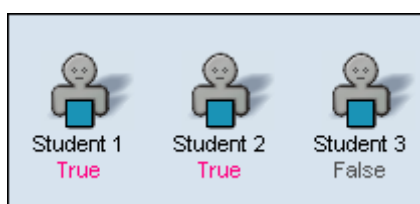

- To ask the next question, repeat step 2. Repeat steps from 2 to 5 until the end of the quiz.

### QUIZ REPORTS

- To end the quiz, click **End**. A quiz report appears.

Quiz report window showing student performance data. Callouts identify: 'Quiz date and time' (24. toukokuuta 2005, 10:45), 'Session color-code' (Student), 'Close the window' (X icon), 'Students who participated in the Quiz' (list of names), 'T. Dixon 4 answers of 5 correct = 80%' (row for Thomas Dixon), '[ ] = correct answer' (legend), and 'F = False T = True' (legend).

| Student's name    | Correct answers |    | Question number |     |     |     |     |
|-------------------|-----------------|----|-----------------|-----|-----|-----|-----|
|                   | count           | %  | 1               | 2   | 3   | 4   | 5   |
| Keith Davidson    | 3               | 60 | T               | T   | [T] | [T] | [T] |
| Kelly Bell        | 4               | 80 | [F]             | [F] | [T] | F   | [T] |
| Robert Farlow     | 4               | 80 | [F]             | T   | [T] | [T] | [T] |
| Maggie Rantaliero | 4               | 80 | [F]             | [F] | [T] | [T] | F   |
| Thomas Dixon      | 4               | 80 | [F]             | [F] | F   | [T] | [T] |
| Fred Dobbs        | 3               | 60 | [F]             | T   | [T] | [T] | F   |
| Donna Hostetter   | 2               | 40 | T               | T   | [T] | [T] | F   |
| Isiak Hauck       | 3               | 60 | T               | [F] | [T] | F   | [T] |
| Sandra Fink       | 4               | 80 | [F]             | [F] | [T] | F   | [T] |
| Vickey Fisher     | 3               | 60 | T               | [F] | [T] | F   | [T] |
| Correct           | 34              | 68 | 6               | 6   | 9   | 6   | 7   |
| Wrong             | 16              | 32 | 4               | 4   | 1   | 4   | 3   |

### PRINTING THE QUIZ REPORTS



You can print the report by clicking the printer symbol on the upper left corner of the report window. The report is printed to the Windows default printer.

### SAVING THE REPORT



By clicking the disk symbol on the upper left corner of the window, you can save the report to your computer or anywhere in the network.

### ZOOMING IN AND OUT THE REPORT VIEW



Note that the font size in the printed report is the same as the one seen on your screen. To zoom the font size in or out, click the symbols on the upper part of the report window. If you zoom the report in or out and print it out, the font size of the print is changed accordingly.

### **VIEWING RESULTS FOR ALL OR BY STUDENT**



You can select whether you want to view (and print) a table of all the results, or a list of the results according to individual students.

### **ADJUSTING THE REPORT VIEW**

The print sheet scales automatically on your screen; to fit the whole report to the sheet you want to print on, you may want to enlarge the report window.

To change the size of the report window, click on a side or a corner of the window, and the mouse button pressed down drag the side or corner to adjust the window size as appropriate.

### **CLOSING THE REPORT WINDOW**



To close the report window, click on the symbol in the upper right corner of the window.

### **REPORT WINDOW TOOLTIPS**

In the Quiz report window, when you move the mouse pointer over a control button, a tooltip text appears telling you what each button on the toolbar does.

8. To quit the session, click **Exit Session**.

### **OPEN / SAVE QUIZ**



If you are going to use the same Quiz settings again in the future, you can save them as a ready-to-use quiz file. This way there is no need to manually define all the settings every time you use the Quiz activity.

The information in the saved quiz files includes the msu audio file, number of questions, type of test (multiple choice, true/false), correct answer, and answering time per question.

You can set the default folder for saving quiz files in **Menu – Properties**.

# AP® EXAM

With Lab 100 you can also accomplish externally-certified activities such as AP® oral exams. Lab 100 is specially designed and ETS certified to set up, test and collect student AP® aural responses. The Lab 100 student audio panel provides a quick, easy and efficient exam vehicle.

The oral part of the AP® Exam lasts 15 minutes, and consists of three sections. The master tape stays in play mode the entire 15 minutes and has the proper gaps for every answer. Each question is repeated twice. The response time for the questions ranges from 15 to 40 seconds.

## **DEFAULT RECORDING SETTINGS**

|                      |                                     |
|----------------------|-------------------------------------|
| Record master track  | <input type="checkbox"/>            |
| Record student track | <input checked="" type="checkbox"/> |

## **PROCEEDING WITH THE AP® EXAM**

Before initiating the actual test, the students perform a test recording, and give their exam number code.

### **BEFORE THE TEST**

Put the exam tape in the tape deck, and test your audio source's audibility.

1. Click **Session Call** to give your students instructions as described in the *Lab 100 Resource Book*.

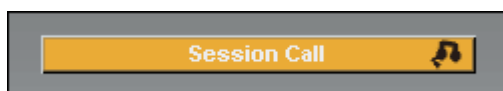

Note that by using the Session Call connection, you can give your students instructions at any point before the actual exam. However, during the exam, no calls are possible.

Clicking the button again ends the call mode. When initiating the exam, if the call mode is still on, clicking the **Start** button (see *Initiating the exam*) ends all the call modes automatically.

### **STUDENTS ENTER THEIR PIN CODE**

2. To start the entering mode for the students' PIN codes, click **Start**.



The students give their exam PIN code by pressing the number keys on their audio panels. The PIN codes appear on your GUI's class view under each session student's icon.

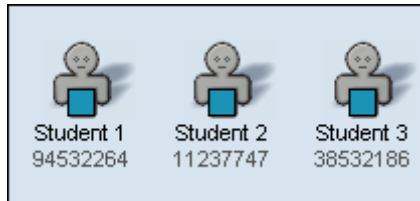

3. To end the entering mode, i.e. to lock the students' audio panels' number keys, click **Stop**.

### ***MISSING OR DUPLICATED PIN CODES***

If some students' PIN codes are still missing, i.e. you end the entering mode before all the session students have given their codes, the following message appears.

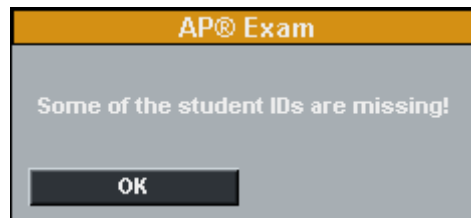

*A message prompting for missing student IDs*

Also, if two students have given the same PIN code, the program prompts for a new code entering.

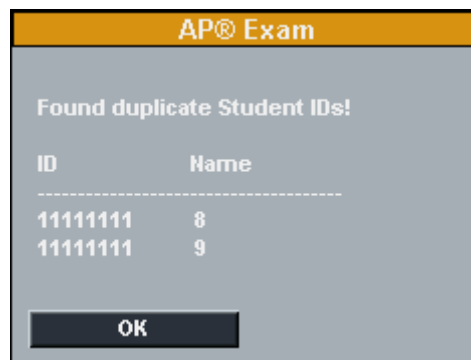

4. In the message panel, click **OK** to restart the entering mode for the missing student codes.

### ***STUDENT VOLUME CHECK AND TEST RECORDING***

Give your students further instructions as described in the *Lab 100 Resource Book*.



The students adjust the volume and perform a test recording by using the controls on their audio panel.

5. To play the students a sample so that they can adjust the volume, click **Sample**.



The source is connected to students. A sample is played for the students so that they can adjust the volume.

To stop the source, click **Stop**.

Next, the students perform a test recording, where they record to their student tracks. You will read a sample aloud, as described in the *Lab 100 Resource Book*. To give the students instructions, click the **Session Call** button.

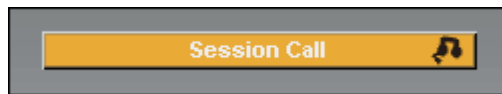

6. To record the sample, click **Record**.

To stop the test recording, click **Stop**.

You will now replay the test recordings to the students.

7. To replay the recordings, click **Replay**.

To stop the replay, click **Stop**.

If a new volume adjustment or test recording is needed, repeat steps from 5 to 7.

You will now ask if the students have any questions. Your microphone is open, so you can communicate to the students without clicking anything more. You can thus answer all questions regarding procedure, and initiate the exam.

### **INITIATING THE EXAM**

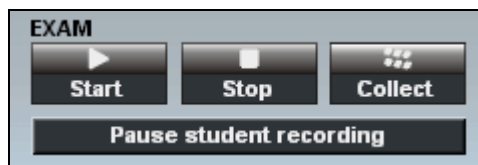

8. To initiate the exam, click **Start**.

- The source is connected to the students, and the recordings start.
- If any calls were on, they are disconnected. During the exam, any connection (calls, monitoring, and intercom) between you and the students is disabled.
- Students hear all further instructions and the exam questions from the exam source and proceed with the exam as instructed.

- The master recorder stays in play mode and the student recorders in record mode throughout the whole exam.
- You can pause the student recorders when needed by clicking on the **Pause student recording** button.

### **ENDING THE EXAM AND COLLECTING THE STUDENT TRACKS**

9. To stop the exam, click **Stop**.

The source is disconnected from the students, and the recordings stop. You can now call the students again.

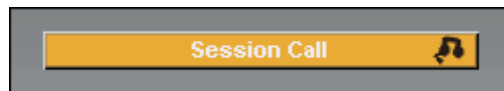

10. If you want to continue the exam, click **Continue**.

In the end of the exam, you will collect the student tracks for later evaluation.

11. To collect the student tracks, click **Collect**. The window for saving the files opens.

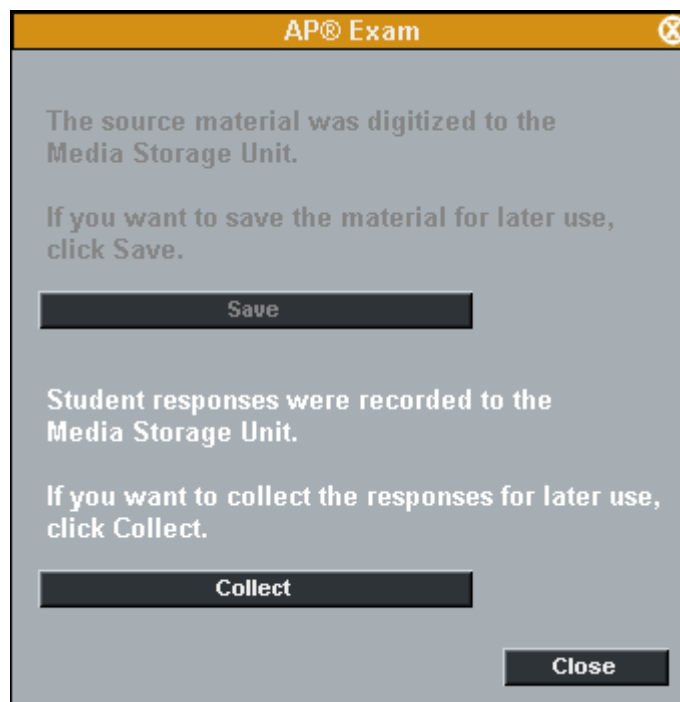

*Panel for saving the master track and collecting the student tracks*

### **COLLECTING THE STUDENT TRACKS**

You may want to collect the student responses for later evaluation.

12. To collect the student tracks, click **Collect**. The following window opens.



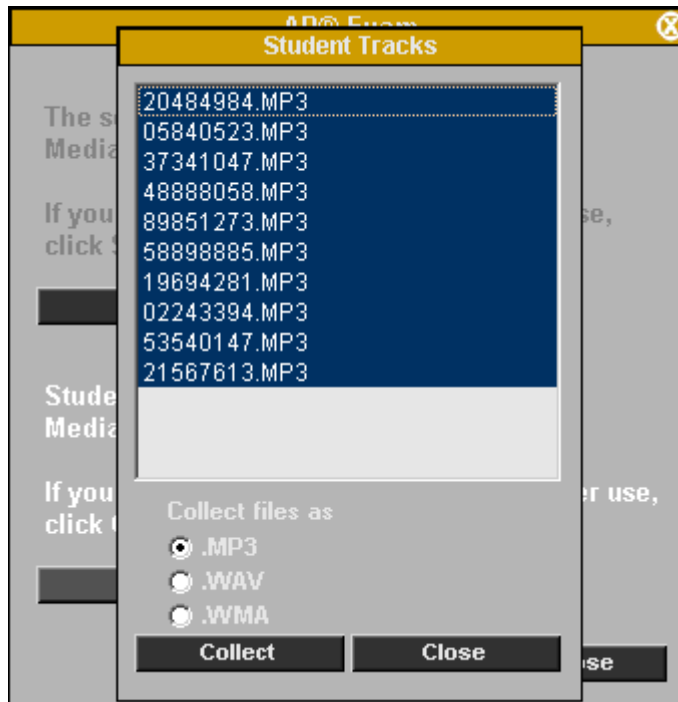

Window for collecting the student tracks

In the window that appears, the recorded student files are displayed; they can be copied and saved to your computer or to any medium accessible from your computer. The default save type is MP3.

The compressing and saving of files may take a few minutes.

13. In the AP® Exam window, click **Save**. A window for browsing for a folder opens. By default, all the files are selected (highlighted). To select only some of the student files click on the display and select the files you want to save. To select more than one file, press and hold down the Ctrl key, and then click on the names of the files you want to select.
14. After you have selected a location for saving the files, the program starts the saving. On top of the AP® Exam window appears a **Saving...** window, where you can view the file that is currently being saved. To cancel the saving, click **Cancel**.

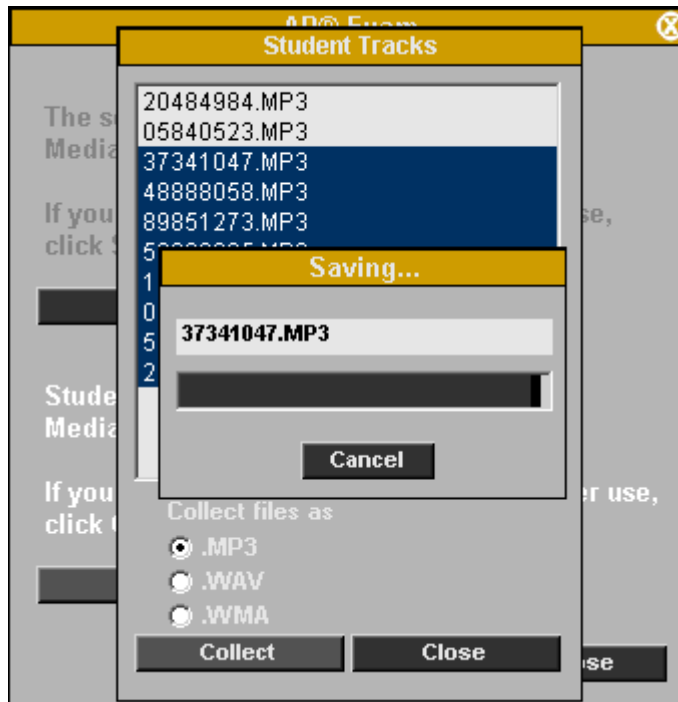

*The program is saving the student tracks*

15. After the saving is completed, click **Close** to exit the window.
16. To quit the session, click **Exit Session**.

## LIBRARY MODE

Library Mode is an activity that allows you to assign audio files to students for their individual work. To assign students to Library Mode, select the student(s) that you want to work individually, and select the MSU file which you want them to work with. You can send the same file to every student, or a different file for each. Even if the students all have the same file, they will still be able to work with their copies of it individually. After the students have performed the test or another exercise, you can save the outcomes for later use.

### PROCEEDING WITH LIBRARY MODE

1. To give instructions, click **Session Call**. To end the call, click the button again.
2. Selecting **Library Mode** from the activities menu list opens a list of available MSU files.

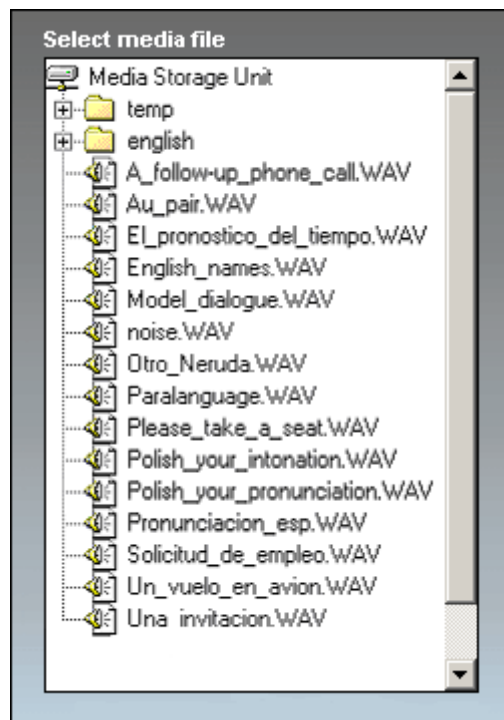

3. Select the file that you want the students to work with by clicking on a file name.
4. Move the mouse pointer onto the class view. Press down the left mouse button and move the mouse pointer over the selected icons to select the students that you want to work with the file. (See below)

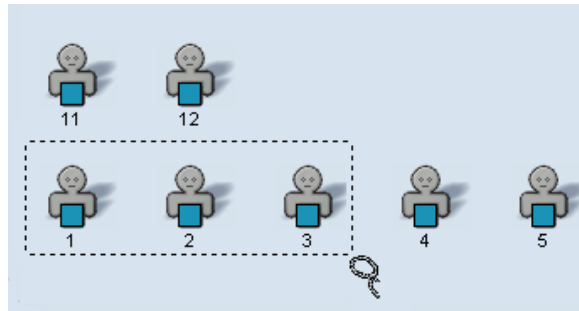

Under the selected icons, you will see the name of the file the students are able to work with.

### **MONITORING STUDENTS**

While your students are working individually, you can listen to them by using the monitoring feature.

5. To monitor a student, click on a student icon. A monitoring panel appears.

→ On how to monitor a student, see chapter *Monitor and intercom* earlier in this guide.

### **EXITING THE SESSION**

6. To quit the session, click **Exit Session**. A window for collecting the student tracks opens.

### **COLLECTING THE STUDENT TRACKS**

You can choose to collect the student tracks for later evaluation.

7. To collect the student tracks, click **Collect**. The following window opens.

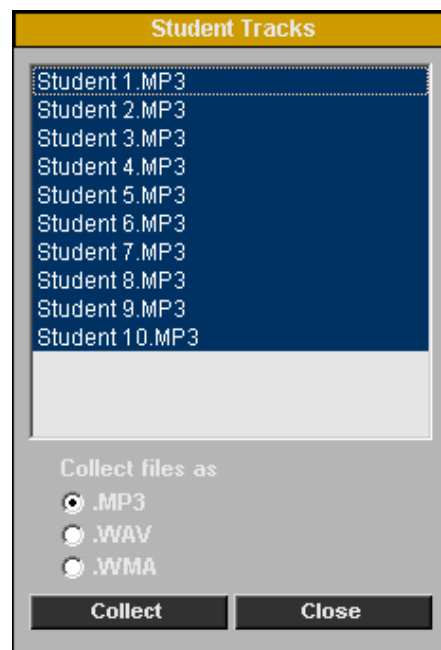

*Window for saving the student tracks*

In the window are displayed the recorded student files, which can be copied and saved to your computer or to any medium accessible from your computer.

You can choose whether you want to collect the files in mp3, wav, or wma format. To change the file format, select the option accordingly.

8. In the window, click **Save**. A window for browsing for a folder opens. By default, all the files are selected (highlighted). To select only some of the student files, click on the display and select the files you want to save.
9. After you have selected a saving location for the files, the program starts the saving. A **Saving...** window appears, where you can view the file that is currently being saved.

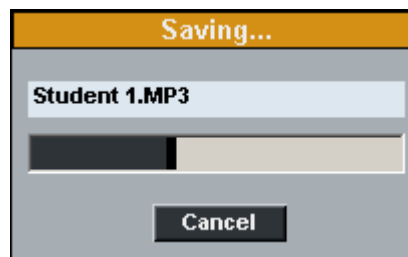

To cancel the saving, click **Cancel**.

10. After the saving is completed, click **Close** to exit the window.

# GEPT

GEPT is short for General English Proficiency Test. It is a standardised English language test in Taiwan. The Lab 100 GEPT activity provides an efficient method of delivery for the GEPT exam and guides teachers through the exam process.

## PROCEEDING WITH THE GEPT EXAM

### ENTERING EXAM CODE

1. Once you have selected the GEPT activity, a dialog will appear asking for the exam code. Enter the seven digit exam batch code and click **OK**.

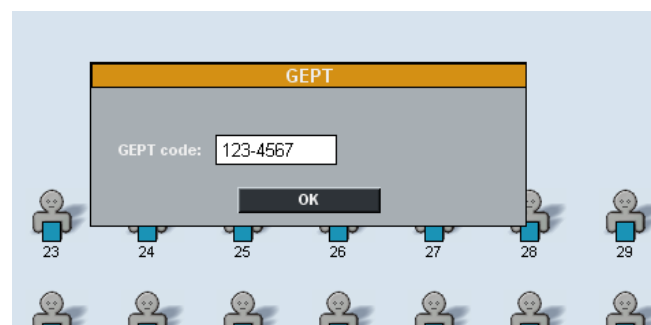

The code is now displayed in the activity window. The student positions are numbered automatically and each student in the session is automatically given a three digit ID number.

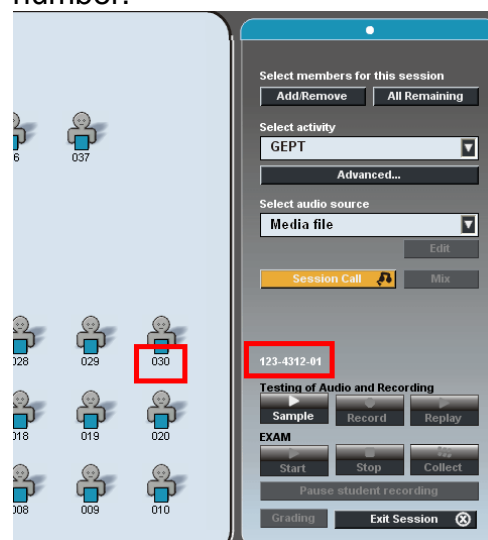

### INSERTING USB DEVICE FOR SAVING STUDENT RECORDINGS

2. Next, before starting the GEPT exam, Lab 100 will ask you to define the folder where student recordings will be saved.

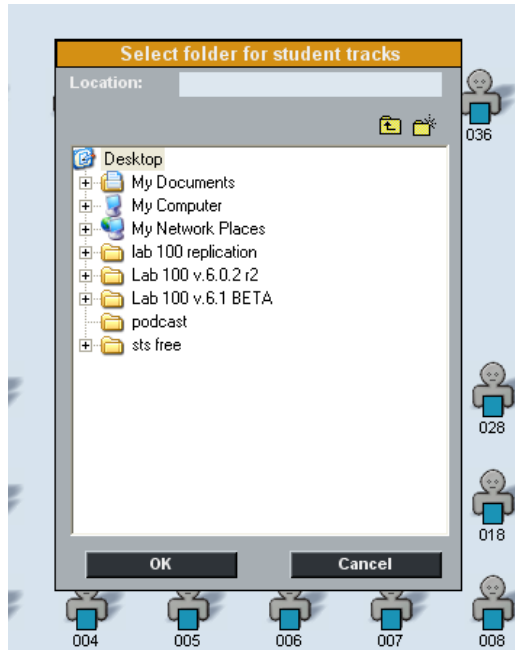

3. Insert a USB memory device into the teacher computer, select it as the student recording save folder and then click OK.

The student recordings will then be collected onto the USB device at the end of the exam.

### ***GIVING STUDENTS INSTRUCTIONS***

4. Click **Session Call** to give your students instructions.

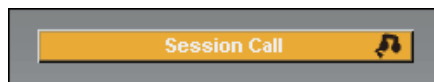

Note that by using the **Session Call** connection, you can give your students instructions at any point before the actual exam. However, during the exam, no calls are possible. Clicking the button again ends the call mode.

### ***ADDING AND REMOVING STUDENTS***

For up to ten minutes after the start of the GEPT activity, you can add extra students to the exam and remove missing students from the layout. If there are empty student positions it is good to remove them from the layout in order to avoid empty student recordings.

## MAKING A TEST RECORDING

Before the actual exam is started, you need to make a test recording to check that all student positions record correctly.

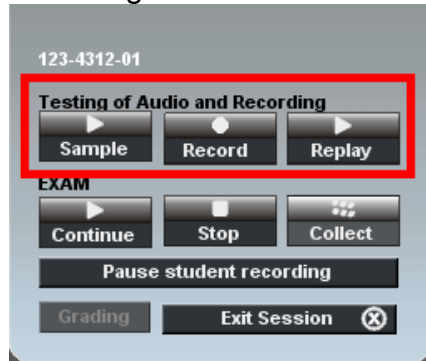

To make a test recording:

5. Click the **Sample** button and speak into the teacher microphone. Check that all the students can hear you.
6. Click **Record** to record the students
7. Click **Replay** to play back the student recordings to the students. Check that all students were able to make a recording.

When proceeding with the test recording, only the function that needs to be used next is available and the others are grayed out.

## SELECTING AUDIO SOURCE FOR EXAM

8. Next, select the **Audio Source** for the GEPT exam.

In a GEPT exam the audio source is always an external analog device, such as a cassette recorder or a CD player.

## PROCEEDING WITH THE EXAM

When proceeding with the GEPT exam, only the function that needs to be used next is available and the others are grayed out.

To proceed with the GEPT exam:

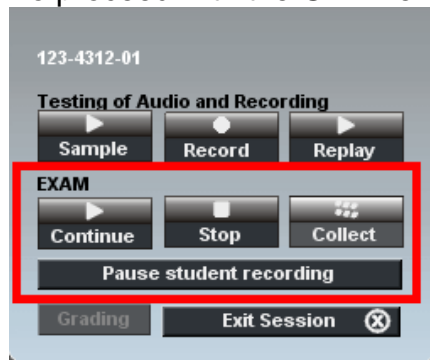

9. Click the **Start** button to play back the audio exam material to the students.



The students are automatically recorded and can simply speak when it is their turn.

10. Click **Stop** to pause the program source when the exam is finished or if you want to pause the exam for a while. If you want to then continue with the exam, click **Continue**.

If you want to pause the student recordings during the exam, click the **Pause student recording button**

11. When the exam is finished, first click **Collect** in the activity view and then click the **Collect** button in the dialog that opens to collect the student recordings to the USB drive that was set as the student collection folder.

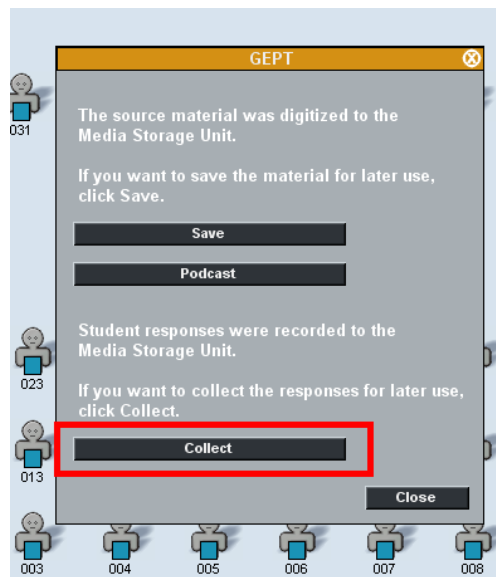

### ***READING THE FILE NAMES OF COLLECTED RECORDINGS***

The audio files containing student recordings are named using the exam batch code that was entered at the beginning of the GEPT exam. The first 7 digits of the file name are the exam batch code (zzz-yyyy). The 8-9th digits indicate the number of the session (xx) that the student was in. The 10-12th (last 3 digits) are the student numbers that were assigned to students automatically (xxx)

## TEM-4

TEM is short for Test for English Majors and it is a standardised English test used in China to test students' college-level proficiency in English. The TEM-4 activity provides an efficient method of delivery for the TEM-4 exam and guides teachers through the exam process.

The TEM-4 Oral Exam consists of three sections. All the sections are recorded to a single media file (or onto a cassette). Student identification is done orally in the beginning of the TEM-4 Oral Exam.

The sources used in this activity are Cassette, Teacher and Media File. The source can be selected at the start of each section. In the beginning of every section, teacher gives the instructions to students.

The teacher is able to monitor the students during the exam, both individually and with the automonitor function.

### PROCEEDING WITH THE TEM-4 EXAM

#### ***BEFORE THE TEST***

1. Click **Session Call** to give your students instructions.

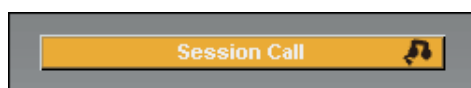

Note that by using the **Session Call** connection, you can give your students instructions at any point before the actual exam. However, during the exam, no calls are possible. Clicking the button again ends the call mode.

#### ***SELECTING AUDIO SOURCE***

2. Next, select the **Audio Source** for the exam.

The sources used in a TEM-4 exam are Cassette, Teacher and Media File.

#### ***ENTERING STUDENT ID'S***

3. Click on **Start** under Entering Student ID's.

Students can now enter their eight digit student ID number with the bookmark buttons on the User Audio Panel.

#### ***MAKING A TEST RECORDING***

Before the actual exam is started, you need to make a test recording to check that all student positions record correctly.

To make a test recording:

4. Click the **Sample** button and speak into the teacher microphone. Check that all the students can hear you.
5. Click **Record** to record the students
6. Click **Replay** to play back the student recordings to the students. Check that all students were able to make a recording.

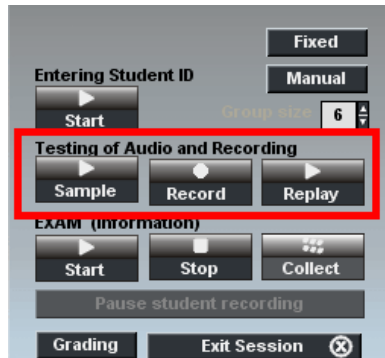

If there are any audio issues in any of the student positions, the students will now have time to switch to another one.

When proceeding with the test recording, only the function that needs to be used next is available and the others are grayed out.

### **RECORDING STUDENT INFORMATION**

To record student information:

7. Click the **Start** button. The students are now automatically recorded and tell their name and other student information if required.
8. Click **Stop** when all the students have recorded their student information.

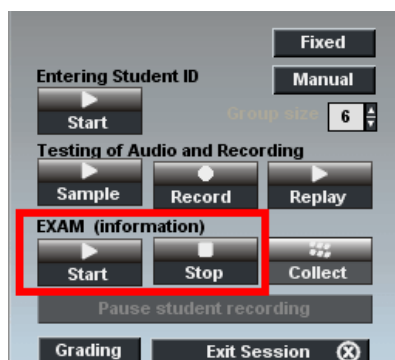

When recording student information, only the function that needs to be used next is available and the others are grayed out.

## PROCEEDING WITH SECTION ONE

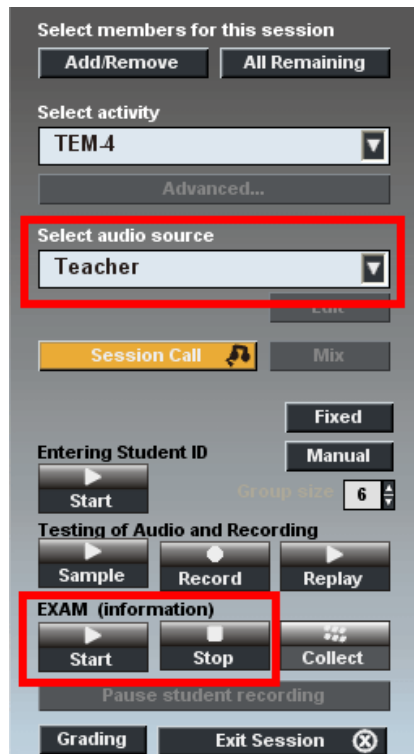

9. Click **Start** to explain Section One to students. When you have finished giving instructions to students, click **Stop**.
10. Select the **Audio Source** for section one
11. Click the **Start** button to play back the audio exam material to the students for the first time. The material is recorded onto the student UAPs during the first playback. Click **Stop** when the material is finished. Repeat the procedure to play the material for students a second time..

After the students have heard the audio material twice, their recorders are automatically paused for three minutes while the students have time to prepare.

12. When the three minutes have passed, click **Continue**. The students are now automatically recorded for three minutes.

After the three minutes have passed, the student recorders are automatically paused.

## PROCEEDING WITH SECTION TWO

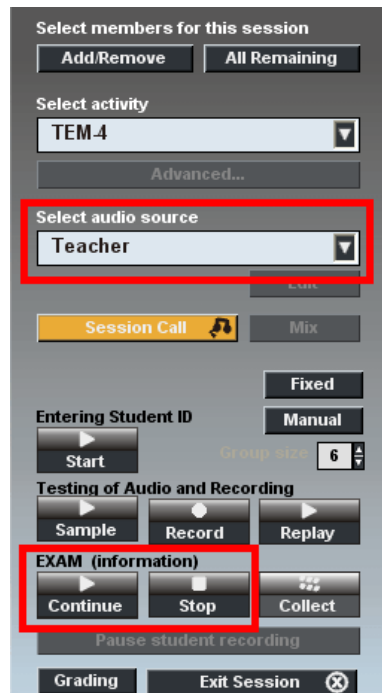

13. Click **Continue** to explain section two of the exam to students. When you have finished giving instructions to students, click **Stop**

14. Select the **Audio Source** for section two

15. Click the **Start** button to play back the audio exam material for the second section to the students. The material is recorded on the student recorders during the playback. Click **Stop** when the material is finished.

After hearing the audio material, student recorders are automatically paused for three minutes while the students have time to prepare.

16. When the three minutes have passed, click **Continue**. The students are now automatically recorded for three minutes.

After three minutes have passed, the student recorders are automatically paused.

## PROCEEDING WITH SECTION THREE

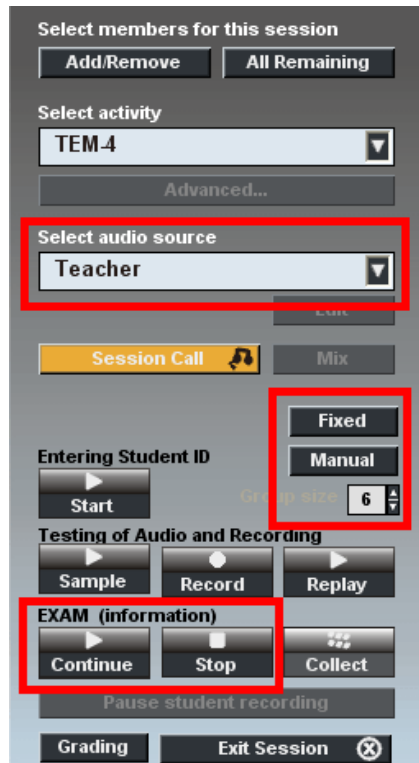

17. Click **Continue** to explain section three of the exam to students. When you have finished giving instructions to students, click **Stop**

The students will now have three minutes to prepare.

18. Select the **Audio Source** for section three

19. Select **how many students will be in a group** and then assign the students into groups with either the **Fixed** or **Manual** function.



**Fixed** – the students will be automatically divided into groups in order according to their student numbers.

**Manual** – you can select the groups manually by clicking on student icons to select them to the active group.

Once the groups have been selected, the students have three minutes to prepare.

20. When the three minutes have passed, click **Continue**.

The students are recorded for four minutes and are free to discuss. The entire group discussion is recorded on the student track of each student.

When the four minutes have passed, the student recordings automatically stop and a window pops up on the teacher screen where you can collect the student recordings.

### **COLLECTING STUDENT RECORDINGS**

When the TEM-4 exam is finished, a window pops up on the teacher screen where you can collect the student recordings.

21. Click **Collect** and browse for a suitable location where the recordings will be saved.

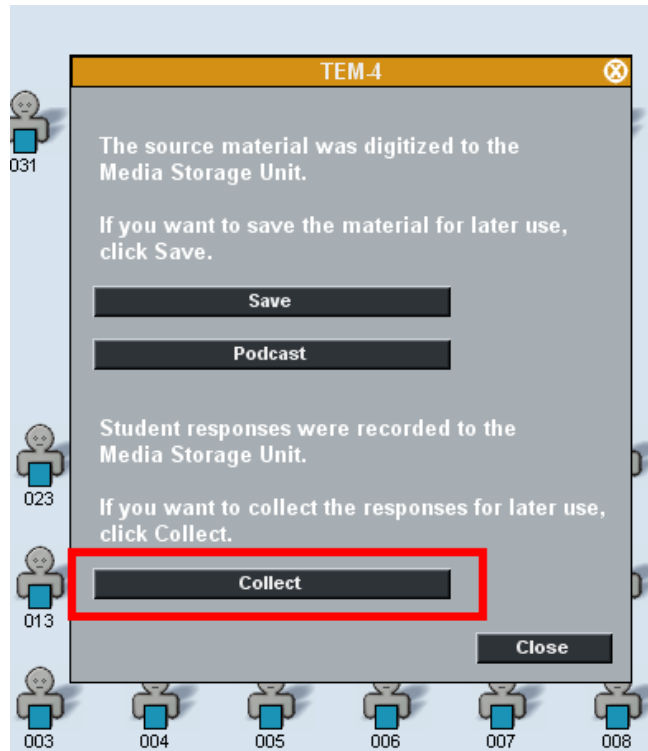

### **READING THE FILE NAMES OF COLLECTED RECORDINGS**

The audio files containing student recordings are named using the eight-digit student ID numbers that students entered at the beginning of the TEM-4 exam, the student position numbers and the current date in the following manner: "xxxxxxx\_zz\_yyyymmdd.mp3". The first 8 digits of the file name are the student ID number, the following two digits are the student position number in the Lab 100 system and the final part of the file name is the date of the exam.

# Q&A

In the Q&A activity you can play an audio source to students and then pause it when you want students to answer a question. The students' answers are automatically recorded without the pauses. When you are finished with a Q&A exercise, you can save the Q&A sequence as a file, so you can do the same exercise again easily.

## **DEFAULT RECORDING SETTINGS**

|                      |                                     |
|----------------------|-------------------------------------|
| Record master track  | <input checked="" type="checkbox"/> |
| Record student track | <input checked="" type="checkbox"/> |

## **PROCEEDING WITH Q&A**

1. To give instructions, click **Session Call**. To end the call, click the button again.
2. To initiate the activity, click **Question**. This starts audio source playback to the students.

When you want students to answer a question that was on the audio source, click **Answer**. The audio source is paused and the students' answers are automatically recorded.

3. To continue the audio source playback, click **Question** again.

## **ENDING THE ACTIVITY**

4. To end the activity, click **End**. This opens a window asking whether you want to collect the student tracks.
5. To collect the student tracks, click **Collect** and select a file format for the collection.

## **SAVING Q&A SEQUENCES**

When you are finished with a Q&A exercise, you can save the question and answer sequence that you went through as a file. This allows you to run the same exercise again later without having to manually click the **Question** and **Answer** buttons as Lab 100 will remember the question and answer sequence and will perform the activity automatically.

To save a Q&A sequence, click the **Save** button after you have ended a Q&A exercise. This opens a dialog where you can save the sequence as a .qaa audio file.

To open a saved Q&A exercise, click the **Open File...** button and browse for the saved .qaa file. Once you have selected the appropriate file, select the appropriate **Audio source**, click on the **Start** button and Lab 100 will run the Q&A exercise automatically.



# AUDIO-ON-DEMAND

The Audio-on-Demand activity allows you to assign audio files or an external program source for students' individual work. You can decide who will have access to which audio material, if any. The audio material can be made accessible to the selected students, for example, in a folder, on an audiocassette, or on an audio CD. At the end of the session, the student recordings can be collected.

The main steps of the Lab 100 Audio-on-Demand activity are as follows:

- Teacher selects audio for the students' individual working,
- Teacher hands out a Source list report for students to inform them about the available media,
- Students access the media the teacher has selected for them by entering a number code in their audio panels.

## PROCEEDING WITH AUDIO-ON-DEMAND

1. To give instructions, click **Session Call**. To end the call, click the button again.

Selecting **Audio-on-Demand** from the activities menu list opens the dialog for defining the recording time.

2. In the **Audio-on-Demand** dialog, define the length of the recording by clicking on the arrow buttons, and click **OK**.

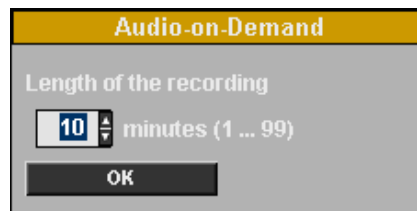

3. In the **Select media** window, that opens when you select the Audio-on-demand activity, check a box next to the desired media type.

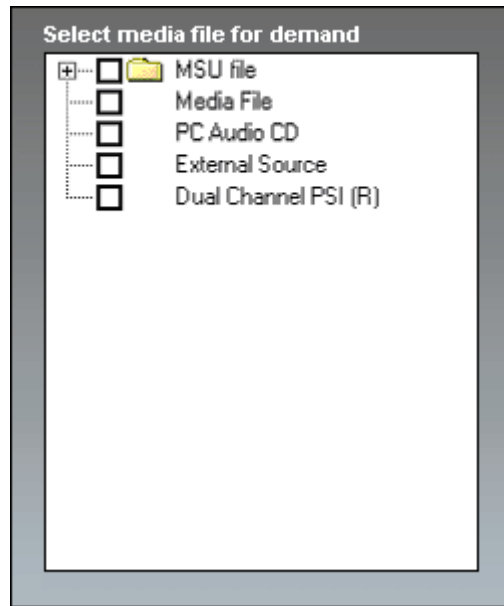

4. Select a file and/or other audio source as described in *Selecting files for students* below.

### **SELECTING FILES FOR STUDENTS**

The difference between MSU files and other media files is that in case of MSU files, it is possible to select multiple files at once for the students to play, whereas in the other case, it is only possible to select one file at a time to be played.

Note that it is not possible to simultaneously play audio that uses your computer's soundcard because the outputs of such audio sources intermingle (for example, CD audio file and media file).

However, it is possible to play a media file residing on your computer, and simultaneously use an external source device, for example, an audio tape in a cassette recorder.

### **TO SELECT MSU FILES**

Note that, in case of MSU files, you can select multiple files at a time.

- a) Check the box next to the MSU folder to open a list of MSU files.

By default, all MSU files are selected (the corresponding boxes checked). To remove a selection, click the box again. The numbering changes accordingly.

- b) Check the box next to each file that you want to select for your students.

When selected, a number appears next to the box, according to which the students select to play the respective file with their audio panels.

### **TO SELECT MEDIA FILES**

- a) Check the box next to the corresponding media type.
- b) In the dialog that opens, browse for a file.
- c) To open the file for students, in the same dialog, click **Open**.

### **TO SELECT AN AUDIO FROM AN EXTERNAL SOURCE**

- a) Check the box next to the corresponding media type.
- b) Start the source device.

By entering the corresponding number code in their audio panels, the students are also able to listen to the selected audio.

5. If you want to save the current selection of media for later use, click the **Save** button in the Session panel. For a description on saving the media selection, see *Saving file lists* below.

### **SAVING FILE LISTS**

You can save one or more file lists as an .aod file for later use. By saving a selection of media as an .aod file, you can open the same audio sources again for the students. This way you don't have to select the media again, when you want the students to work with it.

To save a file, click the **Save** button, and in the dialog that opens, browse for a saving location, give the file a name, and click **Save**.

To open the saved file list again, click the **Open** button, and in the dialog that opens, browse for the file or folder. The selected file is opened, and you can inform the students of the files they are able to work with, for example, by using the file list report (see below).

### **MONITORING STUDENTS**

While your students are working individually, you can observe their progress. You can choose to monitor students in random order, or you can start the automonitoring feature, which means that you monitor all the present session students one by one.

6. To monitor a student, click on a student icon. A monitoring panel appears.

→ For more information about the monitoring features, see *Monitor and intercom* and *Automonitor*.

## **EXITING THE SESSION**

7. To quit the session, click **Exit Session**. A window for collecting the student tracks opens.

## **COLLECTING THE STUDENT TRACKS**

You can choose to collect the student tracks for later evaluation.

8. To collect the student tracks, click **Collect**. The following window opens.

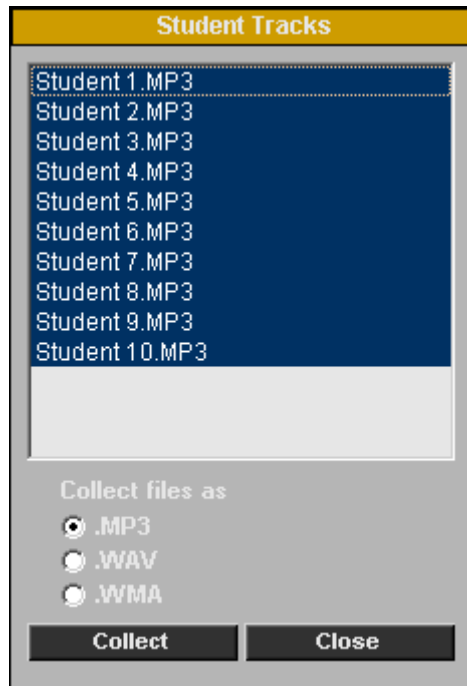

*Window for saving the student tracks*

In the window are displayed the recorded student files, that can be copied and saved to your computer or to any medium accessible from your computer.

You can choose whether you want to collect the files in mp3, wav, or wma format. To change the file format, select the option accordingly.

In the window, click **Save**. A window for browsing for a folder opens. By default, all the files are selected (highlighted). To select only some of the student files, click on the display and select the files you want to save.

After you have selected a saving location for the files, the program starts the saving. A **Saving...** window appears, where you can view the file that is currently being saved.

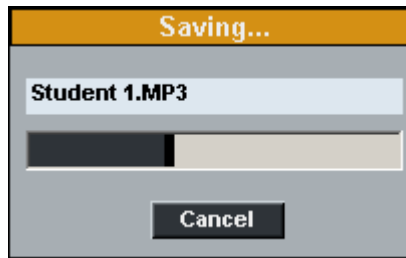

To cancel the saving, click **Cancel**.

After the saving is completed, click **Close** to exit the window.

### ***AUDIO-ON-DEMAND FOR A STUDENT***

#### **OPENING FILES AS A STUDENT**

For example, if the file number is 01, the student presses the appropriate number keys (zero and one) to open the file on his or her audio panel.

If the file is an MSU file, the student also presses the Play key on the audio panel to start the playback, or press record for playback and recording. In other cases, the playback of the file starts automatically when the file number is entered.

#### **CHANGING FILES AS A STUDENT**

To change the file, the student first presses the Call Teacher button and then the appropriate number keys.

#### **FILE LIST REPORT**

By handing out the printed report to students, or by projecting the report for them to view, you can inform the students of the files they are able to work with.

To open the report, click **Report**. The report window opens.

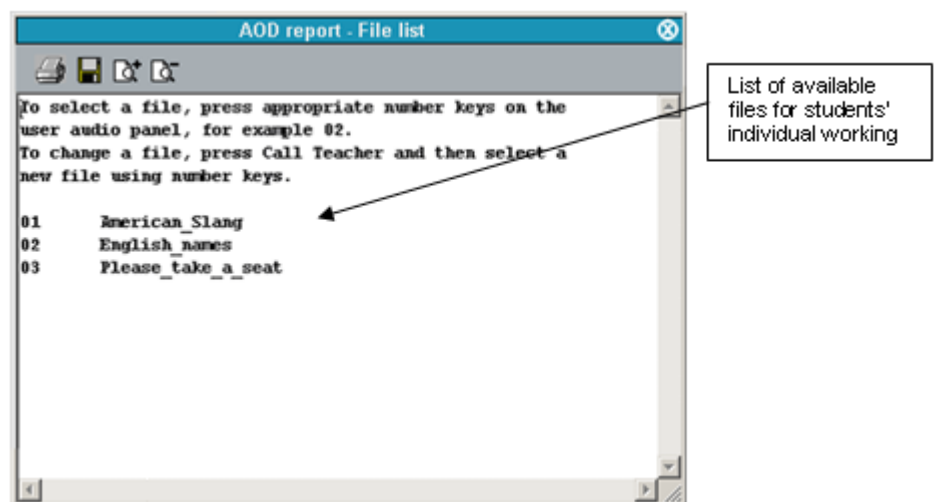

By pressing the appropriate number keys on their user audio panels, the students are able to open the listed files.

## **ABOUT PRINTING THE FILE LIST REPORTS**



You can print the report by clicking the printer symbol on the upper left corner of the report window. The report is printed to the Windows default printer.

## **SAVING THE REPORT**



By clicking the disk symbol on the upper left corner of the window, you can save the report to your computer or anywhere in the network.

## **ZOOMING IN AND OUT THE REPORT VIEW**



Note that the font size in the printed report is the same as the one seen on your screen. To zoom the font size in or out, click the symbols on the upper part of the report window. If you zoom the report in or out and print it out, the font size of the print is changed accordingly.

## **ADJUSTING THE REPORT VIEW**

The print sheet scales automatically on your screen; to fit the whole report to the sheet you want to print on, you may want to enlarge the report window.

To change the size of the report window, click on a side or a corner of the window, and the mouse button pressed down drag the side or corner to adjust the window size as appropriate.

## **CLOSING THE REPORT WINDOW**



To close the report window, click on the symbol in the upper right corner of the window.

# LAB 100 SETUP

## LAB 100 INSTALLATION

- Hardware installation
- Software installation
- Configuration of the teacher PC
- Configuration of the Lab 100 software
- Software update
  - Media Storage Unit (MSU)
  - System Connection Unit (SCU)
  - User Audio Panel (UAP)
  - Teacher PC

## HARDWARE INSTALLATION

### LAB 100 COMPONENTS



#### **System Connection Unit 032 (SCU032)** (6001020)

connects User Audio Panels (both teacher's and students') with audio sources and the Teacher PC.

This model contains 32 ports for User Audio Panels.



#### **System Connection Unit 064 (SCU064)** (6001021)

This model contains 64 ports for User Audio Panels.



**Media Storage Unit 322 (MSU322) (6001010)**

is a media warehouse, where the master tracks can be saved or copied to/from. Once stored in this unit, the saved audio files can be launched on students' audio panels.

Maximum storage capacity in this model is 120 hours of program files.

**Media Storage Unit 642 (MSU642) (6001011)**

Maximum storage capacity in this model is 240 hours of program files.



**User Audio Panel (UAP036), Mounted with metal plate (6001036)**

at each student position, is the tool that students use to participate in a Lab 100 class. The teacher also has a User Audio Panel.

The model that is mounted with a metal plate is firmly attached to the student table by making a hole in the table (W x L = 99 x 145mm) and tightening the screw from under the table.



**User Audio Panel (UAP038), Desktop model (6001038)**

The desktop model is fastened to the table with the help of a metallic plate that is screwed on top of the table. In the



bottom of the UAP there are edges that fit the plate and the panel is locked when it is slid vertically a few centimeters. It can then be released by pressing a spring with e.g. a screwdriver.



**User Audio Panel (UAP037 or UAP039) with PC connection**, Mounted with metal plate (6001037) or Desktop model (6001039)

These UAP models have an additional cable for a PC connection. It can be used to make a connection to the student PC's soundcard or any other program source.



**System Serial Interface (SSI100)** (6001060)

is needed if the system doesn't include a Media Storage Unit (AA Lab). The Serial Interface connects the teacher PC to the System Connection Unit.

**Dual Channel Program Source Interface (PSI046)**  
(6001046)

connects external source devices (such as MP3 player, tape recorder, etc.) to the System Connection Unit. With the Dual Channel Program Source Interface the user can connect two external audio sources to a single SCU port.

### **CABLING**

|   |                               |
|---|-------------------------------|
| Teacher PC – MSU                                    | Cat 5 STP cross-over          |
| MSU – SCU032  | Cat 5 STP cross-over          |
| MSU – SCU064  | 2 x Cat 5 STP cross-over      |
| SCU – Student UAPs                                  | Cat 5 UTP                     |
| SCU – Teacher UAP                                   | Cat 5 UTP                     |
| SCU – Source Interface                              | Cat 5 UTP                     |
| Program Source Interface (PSI046; 3831246) – source | Stereo cable (RCA connectors) |
| Teacher PC – Teacher UAP                            | 3 * 3,5 mm stereo cable       |

Note:

- Cat 5 cables are standard cables used typically for network connections.
- For the connections **SCU – MSU** and **MSU – Teacher** required a cross-over cable.
- The SCU – UAP cable lengths available at SANAKO: 1, 2, 3, 5, 7½, 10, 12½, 15, 17½, 20, 22½, 25, 27½, and 30 meters (gray cables).

### **LAB 100 CONNECTION OVERVIEW**

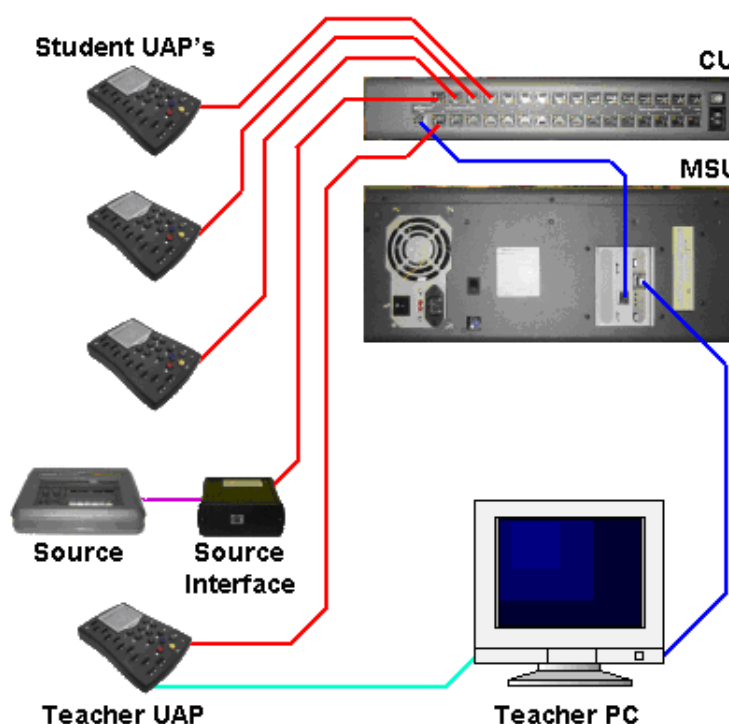

## LAB 100 SCU064 INSTALLATION

### COMMUNICATION PORTS

System Connection Unit 064 (SCU064) has two ports, A and B, which manage the communication between the System Connection Unit and Media Storage Unit 642 (MSU642).

In Media Storage Unit 642, there are equal ports A and B in the back of the PCI cards.

Note that the order of the A and B ports in MSU642 might vary. Always establish the connection according to the port name, not according to its placement.

### CONNECTING UNITS

Before connection, make sure both units are switched off.

Connect units from SCU port A to MSU port A, and from SCU port B to MSU port B. See the drawing below.

### CABLE TYPE

The cable type is CAT 5 Cross Over.

MSU642 contains 2 of these cables when delivered.

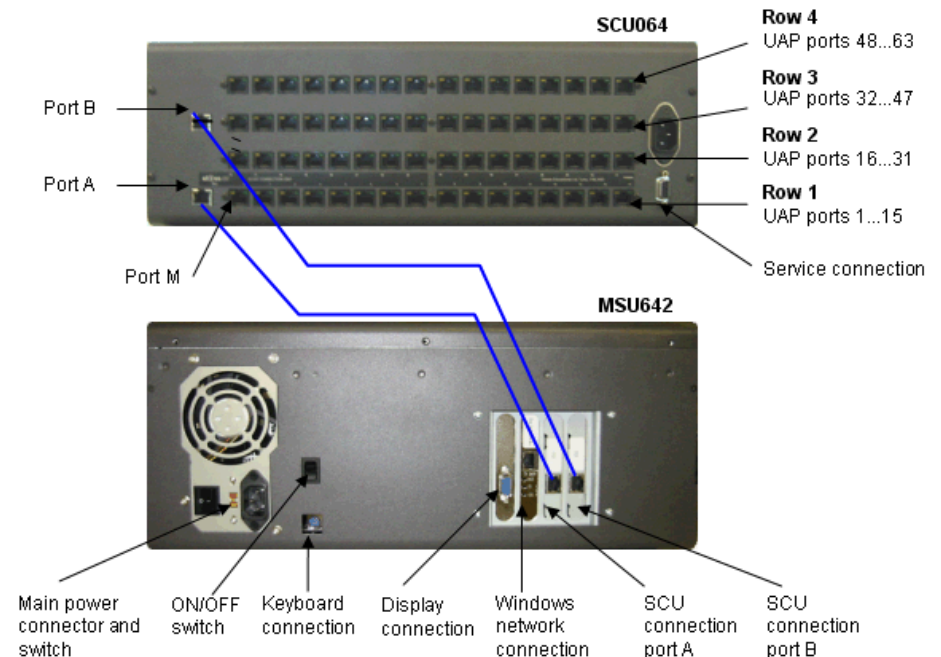

### VERIFYING CONNECTIONS

Between the User Audio Panels and System Connection Unit

- A green LED indicator switches on when the connection is established successfully.
- An orange LED indicator switches on when no connection is established with UAP.

Between the System Connection Unit and MSU

- Both green and orange LED indicators switch on in the SCU and MSU when a connection is established.

### **COMPONENTS NEEDED FOR A LAB OF 20 STUDENT POSITIONS AND AN EXTERNAL AUDIO SOURCE**

- System Connection Unit (includes the power cable)
- Media Storage Unit (includes the cables needed for the SCU - MSU - Teacher PC)
- 21 User Audio Panels (1 teacher + 20 students)
- 22 Lab 100 Cables (1 teacher + 20 students + 1 source)
- Source Interface for the external source

**Note:** The cable between the Source Interface and external source is not included.

Note about the batteries in MSU:

If the backup battery is incorrectly replaced, there is danger of explosion.

Replace only with a battery of the same type.

Do not put the battery pack in trash that is disposed of in landfills. When disposing of the battery, comply with local ordinances or regulations and your company's safety standards.

### **DUAL CHANNEL PROGRAM SOURCE INTERFACE**

The Dual Channel Program Source Interface allows you to connect two external audio sources to a single SCU port

#### **DIAGRAM OF HARDWARE CONNECTIONS**

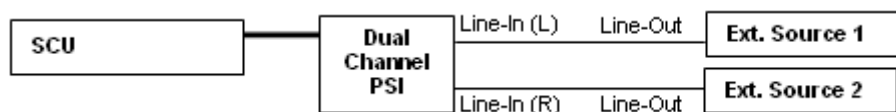

1. The PSI is connected to the SCU with a standard Cat-5E ("LAN") cable.
2. The external sources' Line-Outs are connected to the Dual Channel PSI Line-In with a DIN/RCA cable.

# SOFTWARE INSTALLATION

## MINIMUM REQUIREMENTS

- PC Computer with Microsoft® Windows® XP or Windows Vista™ operating system
- Resolution 1024 x 768 or higher and 16-bit color
- Sound card
- DVD-ROM
- Mouse
- Network interface card
- COM port (for AA Lab only)

## INSTALLING THE LAB 100 PROGRAM

1. Insert the Lab 100 CD-ROM into your computer's CD-ROM drive. The installation wizard starts. If not, open Windows Explorer, select the CD ROM drive, and double-click the 'Setup.exe' file.
2. Select a path for the destination directory.
3. When the installation is completed, click **OK**. It is not necessary to boot the PC.

# TEACHER PC CONFIGURATION

## *WINDOWS XP*

1. Click **Start** to open the Windows main menu.
2. In the menu, point and click **Control Panel**.
3. Select Network Connections.
4. In the General sheet, select Local Area Connections, and click Properties.
5. In the **General** sheet, make sure **Internet Protocol (TCP/IP)** is checked.
6. Double-click the **Internet Protocol (TCP/IP)** option, or click **Properties**.
7. In the dialog window that opens, select **Use the following IP address**.
8. In the **IP address** field, enter 172.24.1.1 and in the **Subnetmask** field, enter 255.255.255.248
9. Click **OK**.

The following settings are needed only when a 3Com Etherlink XL 10 network card is used:

1. In the Local Area Connection Properties sheet (the General tab), click Configure.
2. Select the **Advanced** tab.
3. In the sheet that opens, in the **Property** window, select **Duplex Mode**. In the value field, make sure **Half Duplex** is selected.
4. In the **Property** window, select **Media Type**. Make sure the value set is 100Base Tx.
5. Click **OK**.

## TO SET A WORKGROUP

### WINDOWS XP

1. Click **Start** to open the Windows main menu.
2. In the menu, point and click **Control Panel**, and select **System**.
3. In the window that opens, select the **Computer Name** sheet.
4. In the sheet, click **Change**.
5. Select Workgroup.
6. As workgroup, type "EDUCATIONAL".
7. Click **OK**.

## TO COMPLETE THE CONFIGURATION

Finally, to activate the settings, restart the computer.

## TEACHER PC SOUND CARD MIXER SETTING

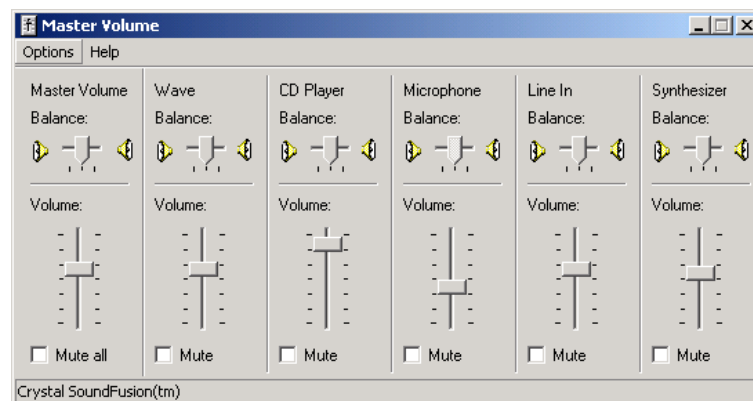

### ***TO SET THE CD PLAYER LEVEL***

Play a CD and listen to the level from the teacher headset. Adjust if necessary.

### ***TO SET THE WAVE LEVEL***

Play a media file and listen to the level from the teacher headset. Adjust to meet the CD player level.

### ***TO SET THE MAIN VOLUME***

Play a media file or CD and adjust the volume.

### **TO ADJUST THE AUDIO LEVEL IN THE SOURCE INTERFACE**

The input level for the Source Interface is 150mV - 2V, which you can set on the input level control on the Source Interface device.

Note 2:

The names of the volume setting options may vary due to differences between sound card types.

# CONFIGURATION OF THE LAB 100 SOFTWARE

## TO CONFIGURE THE LAB 100 SOFTWARE

1. Click **Start** to open the Windows main menu.
2. In the menu, point **Programs**, point **Lab**, point **Lab 100**, and select **Config**. The Lab 100 configuration program is started.



*User Interface of the Lab 100 Configuration program*

In the configuration program, you will

1. set the default settings,
2. find workstations, and
3. set audio sources.

When you configure the Lab 100 software for the first time, follow the given order. However, if you want to modify an already existing configuration, you can apply these steps in free order to match the task you want to accomplish.

To proceed with the class view configuration, make sure the User Audio Panels are connected to the System Connection Unit and the System Connection Unit is switched on.

## SET DEFAULT SETTINGS

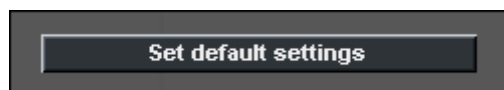

### ***TO SET DEFAULT SETTINGS***

Click the **Set default settings** button. The **Lab 100 properties** dialog window opens.



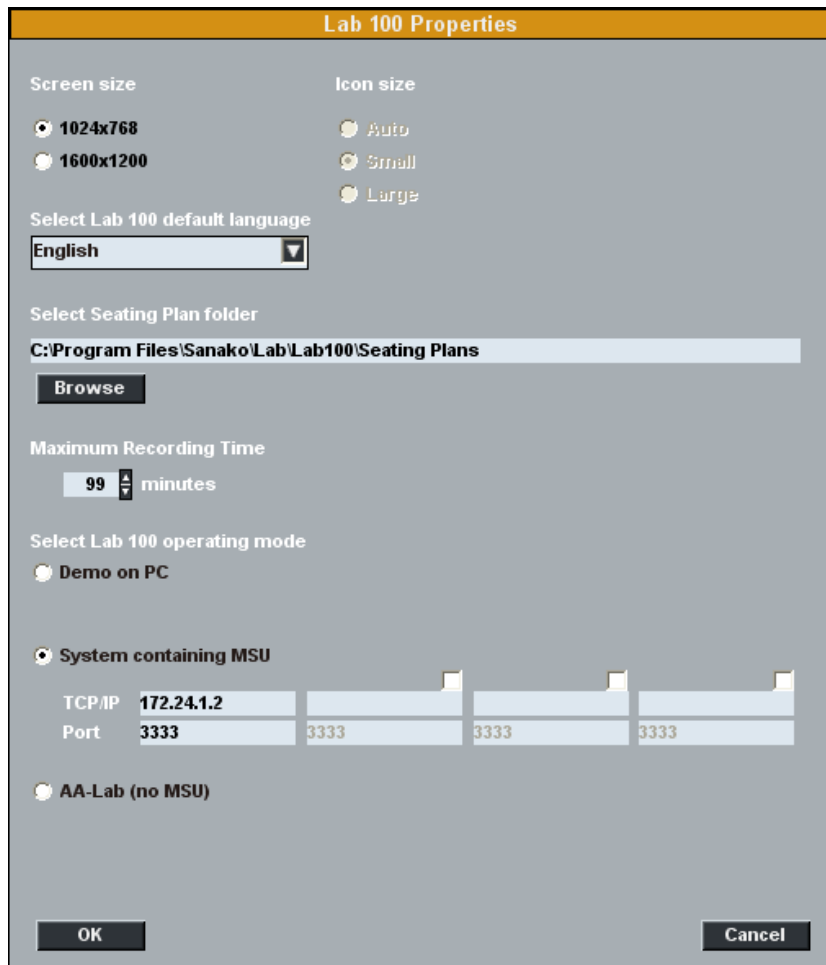

Window for setting Lab 100 properties

In the window, you can choose the default settings for the Lab 100 application. Once defined, settings are always active when starting the Lab 100 application on teacher's PC.

### **SCREEN SIZE**

Select the screen resolution for the teacher computer. The default setting is 1024x768. If you choose the higher resolution, 1600x1200, then you can also adjust the size of the Lab 100 desktop icon with the **Icon size** selection.

### **DEFAULT LANGUAGE**

Select a language for the user interface from the drop-down menu.

### **SELECT SEATING PLAN FOLDER**

Browse to select the folder where seating plan files will be saved.

### **MAXIMUM RECORDING TIME**

You can set a maximum recording time, in minutes, for students. Limiting the recording time helps control the

storage space required by student recordings in the MSU, thus saving storage capacity for program files.

### **OPERATING MODE**

Select you Lab 100 system type, a demo system, a standard Lab 100 system with a Media Storage Unit for audio material, or an AA-Lab, which is a simple audio delivery system without an MSU for file storage.

**Demo on PC** – for demo purpose only, no hardware in the system

**System containing MSU** – This is the selection for standard Lab 100 systems with an MSU. Make sure the TCP/IP value and port number are set correctly for each MSU in the system (both given by default):

TCP/IP: 172.24.1.2.

Port: 3333



If you have a system with multiple MSUs, check the box above the TCP/IP and Port fields to enter the information for each additional MSU. The last number in the TCP/IP address changes for each MSU, but the port number remains the same.

**AA-Lab (no MSU)** – An AA-Lab does not have an MSU for file storage and is used simply as an audio delivery system. In an AA-Lab setup you need to select the COM port where the SSI component is connected.



### **FIND WORKSTATIONS**



When you click the **Find workstations** button, the system starts to scan for connected UAPs. The detected UAPs are displayed as student icons on the class view.

Note:

- Moving the mouse pointer onto a student icon turns the mouse pointer to a four-headed arrow. This means that you can now drag and drop the student icon to a different location.

- When the mouse pointer is on a student icon, clicking the right mouse button opens a menu list. From the list you can
  - a) select to view Workstation Info (displays the workstation's port number) and
  - b) select to remove the position.
- You can also select several student icons at a time and align them as appropriate. To align the icons, do as follows:

With the left mouse button pressed down, drag the mouse pointer over those students' icons you want to align. Color-code on the selected students' icon turns to white indicating that by clicking the right mouse button, you can now select to align the icons to left, right, top, or bottom.

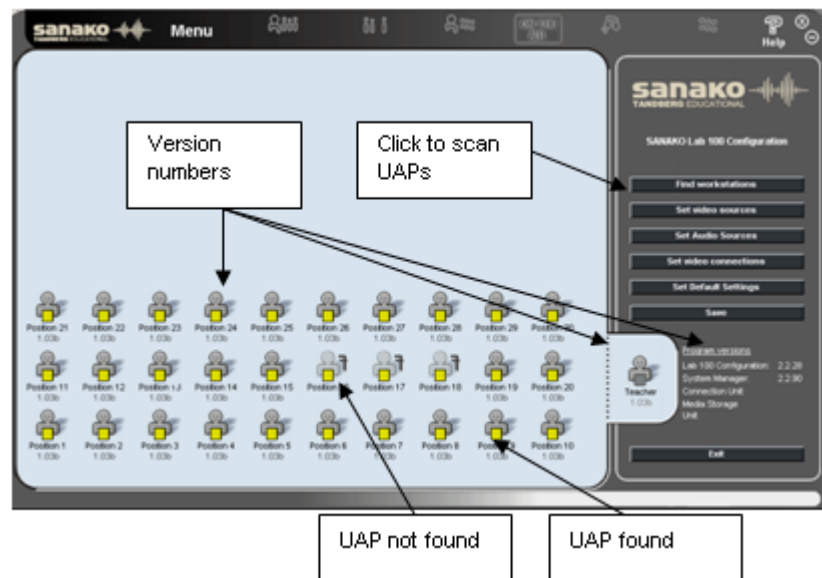

### **TO FIND WORKSTATIONS**

To find workstations, proceed as follows:

1. Click the **Find Workstations** button. The student icons appear on the class view in a default arrangement, where student icon 1 appears in the lower left corner, student icon 2 on its right, etc. You can change the seating plan to match your classroom layout, if needed.



## SET VIDEO SOURCES



Note: Using video sources requires the installation of a separate SANAKO Video Distributor system

### TO SET VIDEO SOURCES

1. Click the **Set Video Sources** button. The following dialog opens.

**Video Sources**

|                                       |                     |
|---------------------------------------|---------------------|
| <b>Title:</b>                         | <b>VD1 - Input:</b> |
| <input type="text" value="No Video"/> | <b>[No Video]</b>   |
| <input type="text" value="Camera"/>   | 1.                  |
| <input type="text" value="Video"/>    | 2.                  |
| <input type="text"/>                  | 3.                  |
| <input type="text"/>                  | 4.                  |

**Port number:**

COM1  
 COM2

2. In the Video Sources dialog, enter the title of the video sources (for example, camera or video) that are connected to the VD1 inputs.
3. Select the appropriate serial port number (e.g COM1, COM2, COM3).

- Click **OK**. The next thing to do is to set the video connections.

For information on setting video connections, see *Set video connections* below.

## SET AUDIO SOURCES



In Lab 100, you can have a variety of audio sources to work with, and you can customize the audio source settings as appropriate. In audio source configuration, you name the sources you want to use in your Lab 100 classes and define where they are connected in the system. When the configuration is completed, you can view the selected audio sources in the Audio Source list in the Lab 100 application.

### AUDIO SOURCE WINDOW

Click **Set Audio Sources**. The following dialog opens.

**Lab 100 Configuration**

|                |                                       |  |
|----------------|---------------------------------------|--|
| <b>Student</b> | <input type="text" value="Student"/>  | <input type="text" value="No Video"/>  |
| <b>Teacher</b> | <input type="text" value="Teacher"/>  | <input type="text" value="No Video"/>  |
| <b>None</b>    | <input type="text" value="None"/>     | <input type="text" value="No Video"/>  |
| <b>MSU</b>     | <input type="text" value="MSU file"/> | Path: <input type="text" value="\\msu\w02\audio"/> <input type="text" value="No Video"/> |

| Source type:         | Source name:<br><small>(Alias name for Lab 100)</small> | Port number:<br><small>Current Set</small> | Video Source: |
|----------------------|---|--|---------------|
| Media File           | Media File  | M  | No Video      |
| PC Audio CD          | PC Audio CD   | M  | No Video      |
| Student Line In      | Student Line In   |  | No Video      |
| External Source      | DVD Player  | 31   | No Video      |
| Dual Channel PSI (L) | Dual Channel PSI (L)                                    | 32   | No Video      |
| Dual Channel PSI (R) | Dual Channel PSI (R)                                    | 32   | No Video      |
| Forwarding port      | Forwarding port   | 33   | No Video      |
| Teacher PC           | Teacher Media Player                                    | M  | No Video      |
|                      |   |  | No Video      |
|                      |   |  | No Video      |

*Lab 100 source configuration window*

There are four pre-defined audio sources at the top of the window:

**Student** – A student microphone is used as the audio source

**Teacher** – The teacher microphone is used as the audio source

**None** – No audio source will be used in the activity

**MSU** – A media file in the MSU will be used as the audio source. The **MSU** audio source requires that you define the MSU drive in the **Path** field.

The fields next to the pre-defined audio sources allow you to edit the source name that will be displayed in the list of available audio sources in the Lab 100 teacher interface.

### **CONFIGURING ADDITIONAL AUDIO SOURCES**

The lower part of the window allows you to configure any other audio sources that are connected to the Lab 100 system. For each source, you need to select a suitable source type, give them a name to be displayed in the Lab 100 audio source list and determine the port to which the audio source has been connected to in the Lab 100 Connection Unit.

| Source type:         | Source name:<br>(Alias name for Lab 100) | Port number:<br>Current    Set | Video Source: |
|----------------------|--|--------------------------------|---------------|
| Media File           | Media File                               | M                              | No Video      |
| PC Audio CD          | PC Audio CD                              | M                              | No Video      |
| Student Line In      | Student Line In                          |                                | No Video      |
| External Source      | DVD Player                               | 31                             | No Video      |
| Dual Channel PSI (L) | Dual Channel PSI (L)                     | 32                             | No Video      |
| Dual Channel PSI (R) | Dual Channel PSI (R)                     | 32                             | No Video      |
| Forwarding port      | Forwarding port                          | 33                             | No Video      |
| Teacher PC           | Teacher Media Player                     | M                              | No Video      |
|                      |  |                                | No Video      |
|                      |  |                                | No Video      |

### **SOURCE TYPE**

Select suitable sources types for the audio sources to be used in the Lab 100 system in the Source Type drop-down menus.

| Source type:         | Source name:<br>(Alias name for Lab 100) | Port number:<br>Current | Set | Video Source: |
|----------------------|--|-------------------------|-----|---------------|
| Media File           | Media File                               | M                       |     | No Video      |
| PC Audio CD          | PC Audio CD                              | M                       |     | No Video      |
| Student Line In      | Student Line In                          |                         |     | No Video      |
| External Source      | DVD Player                               | 31                      |     | No Video      |
| Dual Channel PSI (L) | Dual Channel PSI (L)                     | 32                      |     | No Video      |
| Dual Channel PSI (R) | Dual Channel PSI (R)                     | 32                      |     | No Video      |
| Forwarding port      | Forwarding port                          | 33                      |     | No Video      |
| Teacher PC           | Teacher Media Player                     | M                       |     | No Video      |
|                      |  |                         |     | No Video      |
|                      |  |                         |     | No Video      |

**Media File** Program file on Teacher PC. Launches teacher media player for playback. For information on selecting the default teacher media player, see *My Settings - Properties tab in Lab 100 main menu*.

**PC Audio CD** CD player on Teacher PC.

**Student Line In** Audio source connected to a student UAP

**External Source** Audio source connected to an older single channel PSI (e.g. recorder or CD player)

**Dual Channel PSI** Two external audio sources connected to one SCU port.

**Forwarding port** The Forwarding port option is only used in systems with multiple MSUs and it is not used to add an audio source. In a multi-MSU system, you need to select 'Forwarding port' and then define the SCU ports where PSIs are connected.

**Teacher PC** Any audio that is being played back on the Teacher computer.

When defining source types, video sources must be defined as "External Source", "Dual Channel PSI (L)" or "Dual Channel PSI (R)".

### SOURCE NAME

| Source type:         | Source name:             | Port number: |     | Video Source: |
|----------------------|--------------------------|--------------|-----|---------------|
|                      | (Alias name for Lab 100) | Current      | Set |               |
| Media File           | Media File               | M            |     | No Video      |
| PC Audio CD          | PC Audio CD              | M            |     | No Video      |
| Student Line In      | Student Line In          |              |     | No Video      |
| External Source      | DVD Player               | 31           |     | No Video      |
| Dual Channel PSI (L) | Dual Channel PSI (L)     | 32           |     | No Video      |
| Dual Channel PSI (R) | Dual Channel PSI (R)     | 32           |     | No Video      |
| Forwarding port      | Forwarding port          | 33           |     | No Video      |
| Teacher PC           | Teacher Media Player     | M            |     | No Video      |
|                      |                          |              |     | No Video      |
|                      |                          |              |     | No Video      |

The **Source Name** fields allow you to name the audio sources. The source names will be displayed in the audio source list in the session window of the Lab 100 teacher application. Giving audio sources commonly known names help the user in recognizing the sources when instructing with Lab 100.

## PORT NUMBER

| Source type:         | Source name:         | Port number: |     | Video Source: |
|----------------------|----------------------|--------------|-----|---------------|
|                      |                      | Current      | Set |               |
| Media File           | Media File           | M            |     | No Video      |
| PC Audio CD          | PC Audio CD          | M            |     | No Video      |
| Student Line In      | Student Line In      |              |     | No Video      |
| External Source      | DVD Player           | 31           |     | No Video      |
| Dual Channel PSI (L) | Dual Channel PSI (L) | 32           |     | No Video      |
| Dual Channel PSI (R) | Dual Channel PSI (R) | 32           |     | No Video      |
| Forwarding port      | Forwarding port      | 33           |     | No Video      |
| Teacher PC           | Teacher Media Player | M            |     | No Video      |
|                      |                      |              |     | No Video      |
|                      |                      |              |     | No Video      |

In the **Port Number:** field, select the SCU port to which the source is connected.

If the audio source is connected to the teacher's UAP, select '**M**' as the port number.

The port number selection is grayed out for the Student Line In audio source as it does not require a port number.



## VIDEO SOURCE

| Source type:         | Source name:<br>(Alias name for Lab 100) | Port number: |     | Video Source: |
|----------------------|--|--------------|-----|---------------|
|                      |  | Current      | Set |               |
| Media File           | Media File                               | M            |     | No Video      |
| PC Audio CD          | PC Audio CD                              | M            |     | No Video      |
| Student Line In      | Student Line In                          |              |     | No Video      |
| External Source      | DVD Player                               | 31           |     | No Video      |
| Dual Channel PSI (L) | Dual Channel PSI (L)                     | 32           |     | No Video      |
| Dual Channel PSI (R) | Dual Channel PSI (R)                     | 32           |     | No Video      |
| Forwarding port      | Forwarding port                          | 33           |     | No Video      |
| Teacher PC           | Teacher Media Player                     | M            |     | No Video      |
|                      |  |              |     | No Video      |
|                      |  |              |     | No Video      |

---

Note: Using video sources requires the installation of a separate SANAKO Video Distributor system

---

If a video source is used with the source type, you can select it in the Video Source drop-down list.

### ***SAVING AUDIO SOURCE SETTINGS AND EXITING THE WINDOW***

To save the audio source settings and close the audio source panel, click **OK**. To discard the changes and close the panel, click **Cancel**.

## SET VIDEO CONNECTIONS



---

Note: Using video sources requires the installation of a separate SANAKO Video Distributor system

---

### ***TO SET VIDEO CONNECTIONS***

1. Click **Set Video Connections**. The following dialog opens.

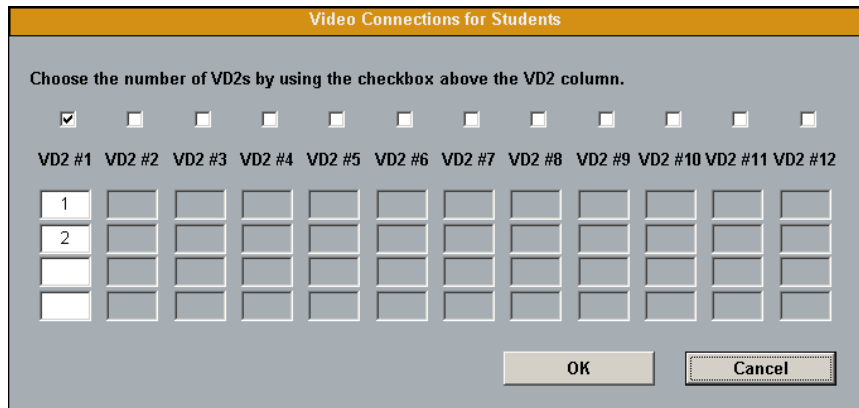

Dialog for setting video connections for students

2. To enable a VD2, tick the appropriate checkbox. The maximum amount of VD2s is 12, allowing 48 student monitors in one classroom.
3. Enter the number(s) of the selected student(s) in the respective field(s).
4. Click **OK**.

## SETTING UP SELF-ACCESS WORKSTATIONS

Self-access workstations can be located anywhere in the network and can be accessed by students for independent study. The self-access group operates outside the sessions in the teacher interface and outside teacher control.

The teacher can set a list of MSU files to be available for the self-access group and students will then be able to study independently using the material. The teacher will also be able to call the self-access group when needed.

To place a workstation into the self-access group, right-click on the workstation icon and select **Move to self access**.

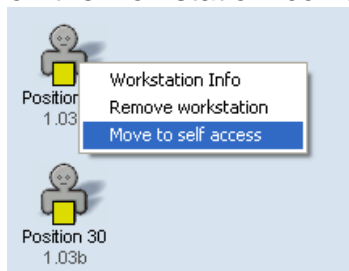

The self access workstations will have white session indicators on the teacher interface and will be without student numbers.

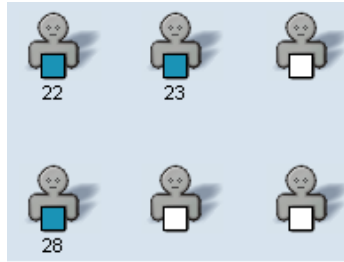

Self-access workstations can be added and removed only in the Lab 100 Configuration application.

# TROUBLESHOOTING

## ***IN THE SYSTEM CONNECTION UNIT, THE GREEN LED IS BLINKING OR NOT AT ALL LIT.***

- The System Connection Unit is not switched on.
- The User Audio Panel is defective.
- Cable is faulty.

## ***LCD OF THE USER AUDIO PANEL IS NOT ACTIVE.***

- Replug the connector between the System Connection Unit and User Audio Panel.

## ***AUDIO CAN'T BE HEARD.***

- Make sure Lab 100 is not in Demo mode.

## ***CD AUDIO OR MEDIA FILE AUDIO CAN'T BE HEARD BY TEACHER OR STUDENTS.***

- Cable from the teacher PC to the teacher's User Audio Panel is not connected properly.
- Windows Mixer Settings are incorrect.
- Wrong sound card selected for Windows.

## ***MSU DOESN'T COMMUNICATE.***

- The LAN adapter settings are incorrect.
- The LAN cable is defective or not connected.

# GLOSSARY OF TERMS

## **ABSENT STUDENT**

The student workstation is not used in the particular class, and the student icon is therefore disabled.

## **ALL CALL**

You can communicate to the whole class at any point by clicking the All Call button on the Lab 100 toolbar. If an audio source is started, your voice is not mixed to the audio source, so clicking All Call mutes the audio sources and the students. If recordings are on, your voice is recorded to the master track.

## **ANSWERING STUDENT**

A student is selected to answer a question. Some students or all the students hear the answering student.

## **ATTENDANCE**

Clicking the Attendance button opens a menu for marking the absent students, naming and renaming the students.

## **AUDIO SOURCE**

In the Lab 100 sessions, you can use various audio and video devices, such as tape recorders, video recorders, CD players, sound cards, etc. You can also choose digitized video and audio material (AVI, WAV, MP3), as well as a student or yourself as the source.

## **AUTOMONITOR**

An easy way of monitoring all the present workstations is the automonitoring scanning mode, where all the present workstations are monitored automatically and consecutively. A replication of the monitored student's audio panel is shown on the Session Screen.

## **BOOKMARKS**

Bookmarks are for marking passages in the audio material, so that you can easily return to the selected parts in the audio material without having to rewind or fast-forward to find the right passage. When you click a set bookmark, the track starts playing from the selected place onward.

## **CALL TEACHER**

A key on the User Audio Panel; by pressing this key, the student can call you, or on Audio-on-Demand activity change the file. On the LCD of the User Audio Panel is shown a teacher symbol.

## **CLASS VIEW**

The Lab 100 class view is the light blue area of the Lab 100 main window. Class view is the layout of your class, in which your students are displayed as student icons.

## **EDIT**

A button on the Session Screen; when your audio source is an MSU file, you can edit the source while you and the students are listening to it. This means that you can communicate to the students without having to manually pause or stop the audio source and the recordings from a separate player.

## **FIXED**

In the Pair and Group Discussion activity, a method to form pairs or groups of the adjacent sitting students.

## **INTERCOM**

Intercom is an interactive connection between you and the student(s); the students hear your voice and are able to reply. In the intercom connection, your voice is mixed to the audio source.

## **LCD**

On the User Audio Panel, the liquid-crystal display (LCD) that shows the student and master track volume, the status of the student recorder, and the counter value (min:sec).

## **LED INDICATOR**

Light emitting diode (LED) is a light that is lit on the User Audio Panel to indicate active answer or bookmark keys. For example, when you set a bookmark, the LED indicator of the pressed bookmark key is lit.

## **MANUAL**

In the Pair and Group Discussion activity, a method to set up pairs or groups. You can freely select the students you want to form a pair or group.

## **MEDIA FILE**

A media file is a digitized audio and/or video file (for example in WAV, AVI, MP3 format) saved on your computer.

## **MEDIA STORAGE UNIT**

The Media Storage Unit (MSU) is where all the master and student recordings are saved in .wav format. Media files can be copied to the MSU from your computer.

## **MIX**

A button on the Session Screen; when your audio source is an MSU file you can mix the source while you and the students are listening to it. This means that you can record your voice to either the master or student track in order to give instructions or comments while the audio source is being played.

## **MONITOR**

Monitoring a student means listening to a selected student's work. In the Group, Pair and Phone Conversation, monitoring a student means monitoring the whole group / both of the members of the pair.

## **MSU FILE**

The Media Storage Unit (MSU) file is a file saved in the MSU, which means that it can be sent to the students for their individual work straight away, without having to listen to the file together first.

## **ON THE AIR**

The *On the Air* sign is lit when your microphone is open and the students can hear you.

## **RANDOM**

In the Pair and Group Discussion activity, a method to set up pairs or groups in random order.

## **RECORDER STATUS**

An ON/OFF button on the toolbar; clicking the button changes the student icons into symbols that display the student recorders' status.

## **REPEAT**

The Repeat function creates a loop of a selected segment of an audio. The beginning and the end are marked with two bookmarks, and the segment can be played back over and over indefinitely.

## **REPLAY**

A button on the Session Screen; if you have recorded the student tracks during the activity, you can replay the tracks for the students. By doing this, you have more time to monitor the students and comment on their work.

## **SEATING PLAN**

A graphical layout of the class; indicates how your students are seated in the classroom. You can create a new seating plan and save it for the future use, or open an already existing plan that you have saved by your name.

## **SESSION**

A session is a group of students performing a learning activity. You can freely choose the number of participants; a session can consist of one single student, a number of students, or the whole class. Altogether you can have up to three sessions.

## **SESSION CALL**

In the Session Screen, an ON/OFF button for giving instructions for the students in the session.

## **SESSION SCREEN**

On the right-hand side of the Lab 100 window, the part of the Lab 100 window where you proceed with the session. In the Session Screen, you will select students, an activity, and audio source for the session. On the Session Screen appear the controls for the activity you select. For example, if you select the listening comprehension activity, only those controls that are necessary to complete the listening comprehension activity appear.

## **SESSION STATUS BAR**

As you create sessions, color-coded status bars stack at the bottom of the Lab 100 window. The Session Status Bar provides useful information about your sessions' status. You can see which activity is in question, and whether the activity is performing or still waiting to be initiated.

## **SESSION STUDENT**

The student is a member of a session. A Session student is color coded to the session he or she is a member of.



## **STUDENT CALL**

Right mouse click and hold is Student Call. In Student Call, the selected student hears you as long as the right mouse button is pressed down, but is unable to reply.

## **SYSTEM CONNECTION UNIT**

The System Connection Unit makes sure the connection between you and the students and/or audio source is successfully established.

## **TOOLBAR**

Toolbar is the horizontal bar on the upper part of the main window. In the toolbar, you find the basic functionality of the program. This is where you find main menu, create a new class view or retrieve one, mark students absent, (re)name students, and create sessions.

## **TOOLTIPS**

On the lower part of the Lab 100 window, between the class view and Session Status Bar, a 'bar' that guides you throughout your class. The tooltip texts on the right-hand side of the bar tell you what you can do in different parts of the Lab 100 window. On the left-hand side of the Status bar is displayed the teacher's name and class ID, after which the current seating plan is named.

## **USER AUDIO PANEL**

Student's user interface. By pressing the keys on this audio panel the students can record to their student tracks, answer quiz questions, set and search for bookmarks, etc. Also you, as teacher, have a User Audio Panel.



# INDEX

## A

About... 41  
Absent/Present 47  
Activities 3, 5, 52  
    AP® Exam 53, 111  
    Audio-on-Demand 54, 131  
    Consecutive Interpreting 53, 102  
    editing activity list 35  
    GEPT 53, 120  
    Group Discussion 53, 97  
    Library Mode 54, 117  
    Listening Comprehension 52, 84  
    Model Imitation 52, 87  
    naming activities 35  
    Pair Discussion 52, 94  
    Phone Conversation 52, 92  
    Q&A 54, 130  
    Quiz 53, 106  
    Reading Practice 52, 90  
    Recorded Response 53, 104  
    selecting 70  
    Simultaneous Interpreting 53, 100  
    TEM-4 54, 124  
Activity Options 57  
    advanced 57  
    record master track 57  
    record student track 57  
    recording both tracks 58  
    set defaults 58  
    sidetone 58  
Activity options tab 35  
Add/Remove 51  
Administrator password 25  
Advanced Activity Options 57  
All Call 8, 68  
All Remaining 51  
Allowing students access to their recorders 72  
AP® Exam 53, 111  
Attendance 8, 47  
Attendance report 48  
Audio Connections 55  
Audio source 58  
    editing 61  
    Line In 63

media file 59  
MSU File 60  
PC Audio CD 62  
    selecting 71  
    setting 151  
student, pair, group 36, 62  
teacher 63  
teacher PC 63  
video audio 63  
Audio-on-Demand 54, 131  
    for a student 135  
    saving file lists 133  
    selecting files for students 132  
Automonitor 66

## B

Background collection 33  
Bookmarks 67  
    remove 14  
    search 14  
    set 13  
    setting for students 68  
students setting bookmarks 68

## C

Cabling 140  
Call Teacher 13  
Calls 68  
    All Call 68  
    Session Call 68  
    Student Call 69  
CD Audio 62  
Choosing a seating plan 43  
Class view 9  
Collecting the student tracks 74, 75, 118, 134  
    default file format 33  
Components of the Lab 100 main window 7  
Configuration of the Lab 100 software 146  
    default language 147  
    find workstations 148  
    icon size 147  
    maximum recording time 147  
    operating mode 148  
    screen resolution 147  
    seating plan folder 147  
    set audio sources 151  
    set default settings 146  
    set video connections 155  
    set video sources 150  
Configuring Web server 28  
Consecutive Interpreting 53, 102  
Copy files to/from MSU 22  
Creating a seating plan folder 44  
Creating a session 70

## D

Default language 147

- Default settings 33
- Disabling podcasting 27
- Dual Channel Program Source Interface 139, 142

## E

- Editing audio source 61
- Enabling podcasting 27
- Exiting session 73

## F

- File collect format 33
- File launch in student positions 61
- File names 36
- Find workstations 148
- Free 72
  - student recording time 36
- Free mode
  - recording time 36
- Free Mode 82

## G

- GEPT 53, 120
- Grade scale 32
- Grading panel
  - student order 33
- Grading report 80
- Grading students 78
- Grading window 78
- Graphical User Interface 3, 7
  - moving 9
- Group Discussion 53, 97
  - saving to single or separate file 36
- GUI See Graphical User Interface

## H

- Hardware installation 137
- Help 8

## I

- Icon size 147
- ID number code 16
- Installation 137
  - configuration of the Lab 100 software 146
  - hardware 137
  - software 143
  - teacher PC configuration 143
- Intercom 65
  - free mode 66
  - model student 66
- Interface language 26

## L

- Lab 100 STS
  - saving delegate recordings 36

- Language 26
  - default language 147
- LCD display 15
  - symbols 15
- Left mouse button 17
- Library Mode 54, 117
- Line In 63
- Listening Comprehension 52, 84
- Lock mode 12
- Lock Mode 82
- Login
  - student 48
  - teacher 25
- Long filenames 36

## M

- Main menu 7, 22
  - copy files to/from MSU 22
  - exit 41
  - my settings 30
  - properties 24
- Main window 21
  - class view 9
  - close 9
  - components 7
  - minimize 8
  - session screen 9
  - toolbar 7
  - tooltips 10
- Master track 55
  - podcasting 75
  - recording 56
  - saving 74
- Media File 59
- Media player
  - teacher 33
- Media Storage Unit 4, 22, 138
  - copy files to/from MSU 22
- Mix target 58
- Mixing audio source 61
  - mix target 58
- Mode 13
- Model group 36
- Model Imitation 52, 87
- Monitor 64
- Monitor and intercom 64
- Monitoring window
  - position 41
- Moving the Lab 100 Graphical User Interface 9
- MP3 collection 35
- MSU File 60
  - as source 60
  - bookmarks 61
  - creating 60
- MSU replication
  - setting folder 25
- My Settings 30
  - activity options tab 35
  - properties tab 31

## N

Naming students 50  
New Session 8, 51, 70  
  removing a student 51  
  selecting students 51  
Number keys 13

## O

On the Air sign 8  
Opening a seating plan folder 45  
Operating mode 148  
Overview 2

## P

Pair Discussion 52, 94  
  saving to single or separate file 36  
Password  
  administrator 25  
PC Audio CD 62  
Phone Conversation 52, 92  
Podcast  
  configuring Web server 28  
  enabling and disabling 27  
  options 26  
  podcast manager 38  
  podcasting files 38  
  podcasting master track 74, 75  
  remote directories 29  
  removing podcasts 38  
  RSS Feeds 38  
Podcast Manager 38  
Podcast Options tab 26  
Product components 3  
  Graphical User Interface 3  
  Media Storage Unit 4  
  Program Source Interface 4  
  System Connection Unit 4  
  User Audio Panel 4  
Program Source Interface 4  
Properties 24  
  extra recording time 36  
  model group 36  
  podcast options tab 26  
  properties tab 25  
Properties tab  
  in my settings 31  
  in properties 25

## Q

Q&A 54, 130  
  saving Q&A sequences 130  
Quiz 53, 106  
  setting folder for Quiz files 32  
Quiz reports 109

## R

Reading Practice 52, 90  
Record Master Track 57  
Record Student Track 57  
Recorded Response 53, 104  
Recorder controls 14, 66  
Recorder Status 8  
Recorders  
  allowing students access to their recorders 72  
  free 72  
  recording time in free mode 36  
Recording both tracks 58  
Recording the master track 56  
Recording the student track 56  
Recording time  
  students 36  
Recording time for students 147  
Recordings 55  
  changing the default options 56  
  Master track 56  
  Student track 56  
Recovery Application 76  
Remote directories 29  
Removing a seating plan folder 45  
Removing a student from a session 51  
Removing individual seating plans 46  
Repeat OFF 14  
Repeat ON 13  
Replay 73  
Replaying the student tracks 73  
Resetting window positions 41  
Right mouse button 17  
RSS Feeds 38

## S

Saving master track 74  
Saving the Master track 74  
Screen resolution 147  
Seating Plan 7, 43  
  choosing 43  
  default seating plan 32, 43  
  folder for seating plan files 32  
Seating plan folder 147  
  creating 44  
  modifying the default folder 45  
  opening 45  
  removing 45  
Seating plan report 46  
Select activity 70  
Select audio source 71  
Selecting a student to answer a question 81  
Selecting files for students 132  
Selecting members for the session 70  
Selecting students for a session 51  
Self-Access workstations  
  calling 37  
  setting files 37  
  setting up 156  
Session

- creating 70
- exiting session 73
- selecting an activity 70
- selecting an audio source 71
- selecting members 70
- session controls 71
- Session Call 68
- Session controls 71
- Session Screen 9
  - activity options 57
  - session tabs 10
- Session Status Bar 11
  - activity 11
  - duration 12
  - lock mode 12
  - recording tracks 11
  - source 11
- Sessions 2, 5
- Set audio sources 151
- Set defaults 58
- Set video connections 155
- Set video sources 150
- Setting bookmarks 13
- Setting self-access group 156
- Settings
  - default session settings 33
- Setup 137
- Sidetone 58
- Simultaneous Interpreting 53, 100
- Software installation 143
- Starting Lab 100 21
- Student Call 69
- Student icons 17
  - Absent student 18
  - Self-access workstation 18
  - Session student 18
  - Student (basic) 18
  - Student as source 19
  - Student calling 19
  - Student in intercom 19
  - Student in listening mode 18
  - Student in monitor 18
  - Student in speak mode 19
  - Student recorder status 19
  - Student workstation out of order 18
- Student login 13, 48
- Student recordings
  - collection folder 31
  - default file format 33
  - long filenames 36
- Student track 55
  - collecting 75, 118, 134
  - recording 56
- System Connection Unit 4, 137
- System Serial Interface 139

## T

- Teacher call order 33
- Teacher login 25

- Teacher media player 33
- Teacher PC configuration 143
- Teacher's Graphical User Interface 7
- TEM-4 54, 124
- Toolbar 7
  - All Call 8
  - Attendance 8
  - Help 8
  - main menu 7
  - New Session 8
  - On the Air sign 8
  - Recorder Status 8
  - Seating Plan 7
- Tooltips 10
- Tracks
  - collecting 74
  - Master Track 55
  - podcasting 74
  - recording 55
  - saving 74
  - Student Track 55
- Troubleshooting 158

## U

- User Audio Panel 4, 12, 138
  - Call Teacher 13
  - clear 14
  - keys 13
  - LCD display 15
  - Mode 13
  - number keys 13, 14
  - recorder controls 14
  - remove bookmarks 14
  - Repeat OFF 14
  - Repeat ON 13
  - student login 13
  - True / False 13
  - volume controls 14

## V

- Video audio 63
- Video connections
  - setting 155
- Video source
  - setting 150
- Volume controls 14

## W

- Web server
  - configuring 28